

MARS Motors

Replacement Fractional Horsepower Motors
for the HVAC/R Industry

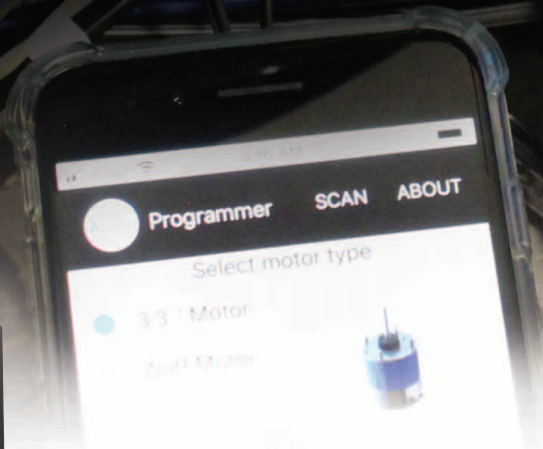

MARS Motors

Page No.

HVAC Motors:

Azure® ECM, Direct Drive	M-3
Azure® ECM, Direct Drive Variable Speed	M-4
Azure® ECM, Condenser Fan	M-4
Azure® ECM, 3.3" Commercial Refrigeration.....	M-5
Azure® ECM, Commercial Refrigeration Watt Motor.....	M-5
Azure® Accessories.....	M-4, M-6
60°C Condenser Fan Motors	M-6, M-7
60°C Condenser Fan Motors (Shaft Up Only)	M-7
60°C Condenser Fan Motors (3 Wire)	M-8
70°C Condenser Fan Motors (208-230V)	M-8
80°C Condenser Fan Motors (208-230V)	M-9
Multi-HP 60°C Condenser Fan Motors	M-9
Multi-HP 70°C Condenser Fan Motors	M-10
70°C Condenser Fan Motors (460V)	M-10
70°C Condenser Fan Motors Shaft Up Only (460V)	M-11
Super-Fit™ Multi-HP 42 Frame Condenser Fan Motors	M-11
Direct Drive Blower Motors	M-12
Direct Drive Torsion Flex Mount Motors	M-13
Multi-HP Direct Drive Blower Motors	M-13
Direct Drive Blower Motors (460V)	M-13
Belted Fan and Blower Motors	M-14, M-15
Commercial Condenser Fan Motors Three Phase	M-15, M-16
Unit Heater Motors.....	M-16
Oil Burner Motors.....	M-17
51 Frame Unit Bearing Motors.....	M-17, M-18
Draft Inducer Blower Motors	M-20

Refrigeration Motors:

Azure® ECM, 3.3" Commercial Refrigeration.....	M-5
Azure® Watt Motor	M-5
Unit Bearing Motors	M-17, M-18
Super-Fit™ C Frame Replacement Motors	M-18, M-19
3.3" Commercial Refrigeration Motors.....	M-19, M-20
One-On-One™ Direct Replacement Motors.....	M-21
One-On-One™ Direct Replacement Motors for Copeland	M-21

Motor Accessories:

Mounting Brackets, Premium Belly Bands & Rheem Adapter Belly Bands	M-22
--	------

Cross Reference:	M-23 – M-28
-------------------------------	-------------

AZURE® ECM

Direct Drive Blower Applications

Ball Bearing

Azure® ECM from MARS is a high efficiency variable speed direct drive blower motor for a multitude of applications. Azure® is a replacement for both standard PSC and Constant Torque motors. These motors cover ratings from 1/5 HP to 1 HP at 115V or 230V and CW or CCW.

Azure® features an auto sizing learn mode. In start-up learn mode, Azure® runs for approximately 2 minutes measuring the external static pressure of the system application. Azure® then assigns torque values to each of its speed taps self-programming itself to the correct horsepower for the application.

If none of the four speeds provides perfect airflow for the application or if duplicate speeds are desired on 2 or more taps, an optional hand held programmer (MARS No. 08502) can be used. The programmer connects to Azure® and displays the percentage of torque applied to the speed tap being energized. The percentage (motor speed) can then be increased or decreased and permanently set with the programmer. This tool overrides the motor torques established in the auto sizing mode. Unlike other electronically commutated motors, an outboard surge protector is included within Azure's® wire harness. This is a replaceable device (MARS No. 08593).

Features:

- Outboard replaceable surge protector
- Adjustable speeds (with optional MARS No. 08502)
- 4 speeds plus 625 RPM constant fan mode
- High efficiency 85%
- Multi-horsepower, dual voltage
- Belly band mount

Specifications:

- Class "B" insulation
- Thermal overload protected
- Operating temperature range: -20°C to 55°C (-4°F to 131°F)
- UL Recognized
- For accessories see page M-6

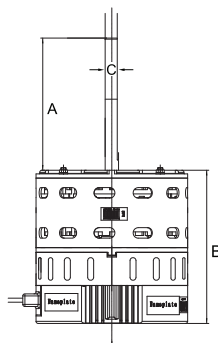

AZURE® ECM

Direct Drive Blower Applications Bluetooth

Ball Bearing

The latest generation of Azure® ECM features integrated Bluetooth control for use with the Azure® ECM smartphone app. While not required for the installation of these motors, the app allows the installer to take full advantage of the ECM technology. While competitive aftermarket ECMs provide only 5 speed taps for setting airflow, the Bluetooth Azure® motors provide more than 50 speed selections and the ability to autosize to the ductwork all with a keystroke or two in the app.

One Touch Autosizing

One touch of a button automatically assigns correct torque for the ductwork; additional programming harnesses are not required.

Individual Speed Tap Adjustments

Dial in the temperature rise with 1% torque increments. Tune out annoying high frequency harmonics. Optimize CFM.

Real Time Data

Monitor motor volts, amps, watts, and RPM's.

Drop-in Installation

Simple to wire; connections are the same as the motor being replaced.

Features:

- 4 speeds plus 625 RPM constant fan mode
- High efficiency 85%
- Multi-horsepower, dual voltage
- Belly band mount

Specifications:

- Class "B" insulation
- Thermal overload protected
- Operating temperature range: -20°C to 55°C (-4°F to 131°F)
- UL Recognized
- For accessories see page M-6

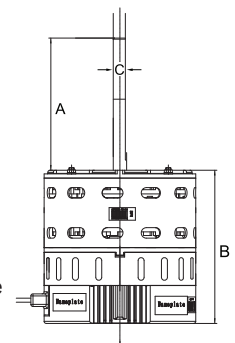

MARS No.	External Surge Protection	Auto-Sizing	Replaces
10860	Yes	Yes	PSC/Constant Torque
10861	Yes	Yes	PSC/Constant Torque
10865	No	No	PSC
10866	No	No	PSC
10867	No	No	PSC

MARS No.	Adjustable Speeds*	Auto-Sizing*	Replaces
10858	Yes	Yes	Constant Torque, Ensite, Endura
10859	Yes	Yes	Constant Torque, Ensite, Endura

* When Azure® Blower Motor App is used

MARS NO.	HP	VOLTS	RPM	ROTATION	DIAMETER	DIMENSIONS		
						A	B	C
10860	1/5-1/2	115/230	1075	Rev	5-1/2	4.93	5.72	1/2
10861	1/2-1	115/230	1075	Rev	5-1/2	4.93	6.66	1/2
10865	1/3-1/2	115/230	1075	Rev	5-1/2	4.93	5.72	1/2
10866	3/4-1	115/230	1075	Rev	5-1/2	4.93	6.66	1/2
10867	1/8-1/3	115/230/277	1075	Rev	5	5.00	5.00	1/2

MARS NO.	HP	VOLTS	RPM	ROTATION	DIAMETER	DIMENSIONS		
						A	B	C
10858	1/5 - 1/2	115/230	1075	Rev	5-1/2	4.93	5.72	1/2
10859	1/2 - 1	115/230	1075	Rev	5-1/2	4.93	6.66	1/2

Azure® ECM

Direct Drive Variable Speed and Constant Torque Blower Applications

Ball Bearing

The newest generation of Azure® ECM featuring integrated Bluetooth control for use with the Azure® ECM smartphone app. While not required for the installation of these motors, the app allows the installer to take full advantage of the ECM technology.

Bluetooth Control

Free app (AZURE ECM) is available on both Apple and Google stores.

Intuitive

Drop down menus and data inputs are simple and make sense.

Plug and Play

Azure connects directly to OEM harnesses; additional module or adapter is not required.

Adjustable Torque

The app allows optimization of airflow even if ductwork is not optimal.

Ultimate Truck Stock

Save time and money. Two Azure ECMs replace A LOT of motors!

Replaces 16 Pin OEM Variable Speed ECM, PWM, 2.0, 2.3, 2.5 EON®; and Evergreen® VS, Rescue® EZ16®

Replaces Many* 4 Pin OEM Variable Speed ECM 3.0; and Evergreen® VS

Replaces Constant Torque X13®, Endura® Pro, SelecTech®, and Evergreen® EM, Rescue® EZ13®

Features:

- 4 speeds plus 625 RPM constant fan mode
- High efficiency 85%
- Multi-horsepower, dual voltage
- Belly band mount

Specifications:

- Class "B" insulation
- Thermal overload protected
- Operating temperature range: -20°C to 55°C (-4°F to 131°F)
- UL Recognized

MARS NO.	HP	VOLTS	RPM	ROTATION	DIAMETER	DIMENSIONS		
						A	B	C
10856	1/4 - 1/2	115/230	1075 Variable	Rev	5-1/2	4.93	5.72	1/2
10857	1/2 - 1	115/230	1075 Variable	Rev	5-1/2	4.93	6.66	1/2

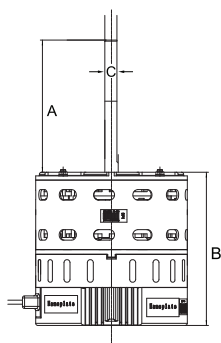

Azure® ECM

Condenser Fan Applications

Ball Bearing

Azure® is an electronically controlled motor (ECM) that replaces a multitude of applications. These motors cover ratings from 1/8 HP to 1/3 HP at 208-230V 825/1075 RPM and 1/3 HP to 1/2 HP 208-230V 825/1075 RPM and CW or CCW. These motors are simple to install. The Azure® condenser fan motors connect the same as a standard PSC condenser fan motor, BUT WITHOUT the capacitor. Just plug the motor into a 115V power source (using supplied programming cable) and select 1 of 4 operating modes and then install the motor:

- 1) 1075 RPM CW (LE) - Factory Default
- 2) 1075 RPM CCW (LE)
- 3) 825 RPM CW (LE)
- 4) 825 RPM CCW (LE)

Unlike other ECM motors, an outboard surge protector is included with the Azure® wiring harness. This is a replaceable device that is much less expensive to replace than replacing the entire motor in the event of a power surge.

Specifications:

- Multi horsepower, self-adjusting
- 825/1075 RPM, single speed
- Reversible rotation
- High efficiency ECM
- No capacitor required
- Water slinger on shaft
- UL Recognized
- For accessories see page M-6

MARS NO.	HP	VOLTS	RPM	ROTATION	ORIENTATION	RHEEM HOLES	DIMENSIONS		
							A	B	C
10874	1/8 - 1/3	208-230	825/1075	Rev	Shaft Down	Yes	6.50	4.33	1/2
10875	1/8 - 1/3	208-230	1075	Rev	Horizontal	No	6.50	4.33	1/2
10872	1/3 - 1/2	208-230	1075	Rev	Horizontal	No	6.00	5.95	1/2

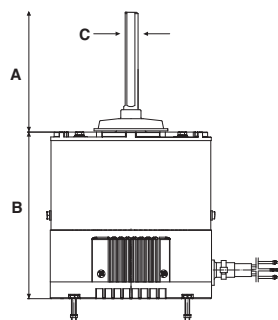
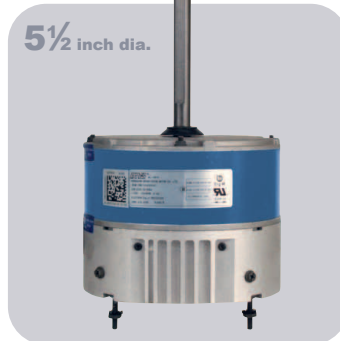

Azure® Variable Speed Motor Adapter

The Azure® Variable Speed Motor Adapter is a money saving solution to the expensive replacement of a failed OEM variable speed blower motor using an Azure® ECM motor. Simply move the OEM wire harnesses to the Azure® Variable Speed Adapter and connect the Azure® direct drive motor speed taps to the Azure® Variable Speed Adapter.

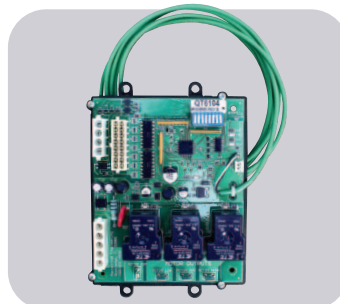

- Allows replacement of 2.0, 2.3, 2.5, and 3.0 variable speed communicating ECM motors
- Allows replacement of variable speed communicating ECM motors from Nidec / US Motors, and Emerson
- Eliminates wasted time & money locating OEM motor
- Allows replacement of all variable speed direct drive ECM 115V / 230V 1/3, 1/2, 3/4, 1HP (not for use to replace X13 style constant torque ECM)

MARS NO.	DESCRIPTION	AZURE® MOTOR COMPATIBILITY
08506	Variable Speed Motor Adapter	10865, 10866

AZURE® ECM

3.3" Commercial Refrigeration Evaporator Fan Motor

Ball Bearing

Azure® is an electronically controlled 3.3" motor (ECM) that replaces all 1/15 - 1/25 HP, 115/230V, and 1550/600 RPM commercial refrigeration evaporator fan motors for walk in cooler/freezer applications. For 1550 RPM, this motor connects easily to the fan controller via a standard Lyall plug. For 2-speed applications, the Lyall plug can be removed and the motor can be wired directly to a separate 2-speed control module using the included second speed tap for 600 RPM. Motor rotation is set using a simple jumper wire. Azure® is rated for 115V or 230V with nothing to set; plug it in to either voltage and it adapts to the correct voltage.

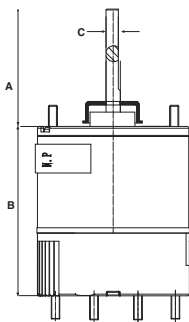

Specifications:

- Operating temperature range: -40° to 131°F
- Multi horsepower, self adjusting from 1/15 to 1/25HP
- Reversible rotation
- Auto voltage select (115/230V)
- High efficiency ECM technology
- No capacitor required
- UL Recognized
- For accessories see page M-6

MARS NO.	HP	VOLTS	RPM	SPEEDS	ROTATION	DIMENSIONS		
						A	B	C
10850	1/15 - 1/25	115/230	1550	1	Rev	2.5	3.74	5/16
10852	1/15 - 1/25	115/230	1550 ⁽¹⁾	1 or 2 ⁽²⁾	CCWLE ⁽³⁾	2.5	3.74	5/16

(1) 1550 default; adjustable 600-2000 RPM with optional wireless programmer kit (MARS No. 08505)
 (2) 2-speeds attainable with optional wireless programmer kit (MARS No. 08505) and optional thermistor kit (MARS No. 08515)
 (3) CCWLE default; reversible with optional wireless programmer kit (MARS No. 08505)

AZURE® ECM

Commercial Refrigeration Watt (Reach-In) Motor Ball Bearing

MARS ECM watt motor is a Drop in replacement for most OEM / ECM / PSC and standard shaded pole commercial refrigeration evaporator and condenser fan motors. Capable of replacing most 1550 RPM case motors 4 - 25W for reach-in cooler/freezer applications. The microprocessor sets power output to match the fan load ensuring correct CFM and maximum efficiency in every installation. Automatically senses and adapts to the system voltage (115/230V). MARS No. 10891 - Wirelessly Programmable. Download Azure® ECM App to your smart phone/tablet.

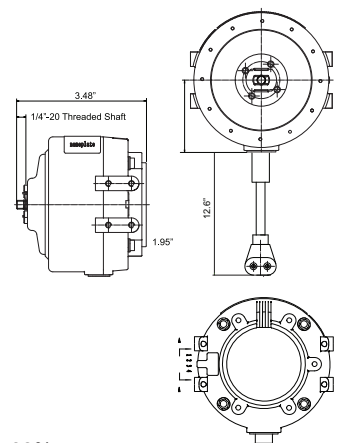

Specifications:

- Submersible - IP67
- Operating temperature range: -40° to 131°F
- Self adjusting from 4 to 25 Watts
- 1550⁽¹⁾ RPM
- CWLE⁽³⁾ Rotation
- Auto Voltage Select (115/230V)
- High efficiency ECM technology: 68%
- Estimated Energy Savings: \$33/year (\$46/year total)⁽²⁾
- 90° Angle Lyall Plug
- Water Resistant: Yes
- UL Recognized
- For accessories see page M-6

Fan Load	Power Consumption	
	Standard Motor Power Consumption	Azure® Power Consumption
4 W	28 W	6 W
9 W	47 W	14 W
16 W	77 W	30 W

MARS NO.	WATTS OUTPUT	VOLTS	RPM	ROTATION	LEAD LENGTH
10891	4 - 25	115/230	1550 ⁽¹⁾	CWLE ⁽³⁾	13"

(1) 1550 default; adjustable 600-2000 RPM with optional wireless programmer kit (MARS No. 08505)
 (2) Estimated energy savings based on replacement of a 9W shaded pole evaporator fan motor with Azure® at \$0.11/kWh. \$33 savings is based solely on the reduction of power consumption. An additional savings of approximately 40% will result from the reduction of the refrigeration load due to Azure®'s lower operating temperature.
 (3) CWLE default; reversible with optional wireless programmer kit (MARS No.08505)

Accessories for Azure® ECM

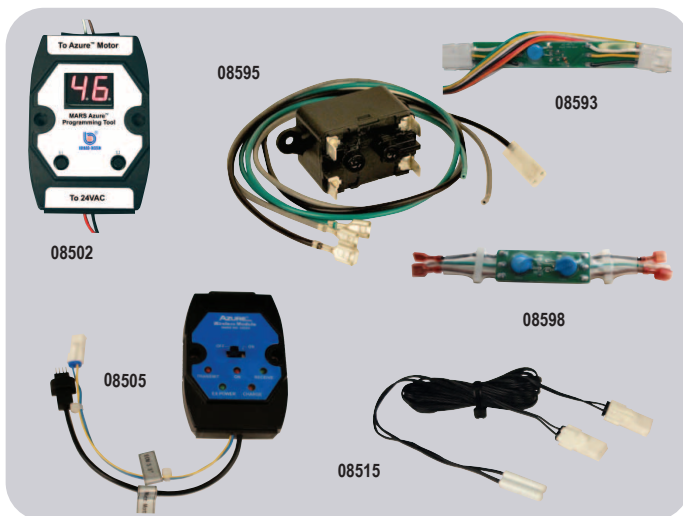

MARS NO.	DESCRIPTION
08502	Hand Held Programmer 10860/10861/10865/10866/10867/10868/10869
08593	Replacement Surge Protector 10860/10861
08595	Constant Fan Kit 10858/10859/10860/10861/10865/10866
08598	Replacement Surge Protector 10872/10874/10875
08505	Wireless Programmer Kit; Requires Azure ECM App and Smart Device (sold separately) for 10891/10852
08515	Thermistor Kit for 2-Speed Operation (2/PK) for 10852; Controls up to 5 Motors

Tech Tip

All ECM motors are more energy efficient than standard motors even though the amp draw may be similar. ECM motors have lower power factors and thus consume fewer watts. Power Consumption (Watts) = Volts x Amps x Power Factor.

Outdoor Condenser Fan Motors

Ball Bearing

MARS all angle outdoor condenser fan motors are designed for either shaft-up or shaft-down applications. End shields are enclosed for weather protection. A weep hole is provided in each end shield to allow condensate to drain. All of these motors are suitable for air conditioning or heat pump applications.



Features:

- All angle
- Rheem mounting holes w/screws installed
- Water slinger on shaft
- Thru bolt or band mounting
- Capacitor requirement noted on motor label
- Double full flatted shaft

Specifications:

- Class "B" insulation
- Single phase, 60 Hertz
- Thermal overload protected
- Fan duty, continuous, air over
- Totally enclosed
- 36 inch leads
- UL Recognized

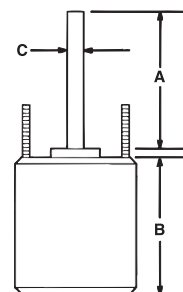

Reversible Rotation – Single Speed

MARS NO.	HP	VOLTS	AMPS	CAP REQ.	ENCL.	BRG.	DIMENSIONS		
							A	B	C
1075 RPM									
10725	1/8	208-230	0.72	5/370	TEAO	Ball	6.50	4.12	1/2
10727	1/6	208-230	0.90	5/370	TEAO	Ball	6.50	4.23	1/2
10726	1/5	208-230	1.17	5/370	TEAO	Ball	6.50	4.12	1/2
10728	1/4	208-230	1.8	5/370	TEAO	Ball	6.50	4.23	1/2
10729	1/3	208-230	2.4	7.5/370	TEAO	Ball	6.50	5.23	1/2
10730	1/2	208-230	3.5	10/370	TEAO	Ball	6.50	5.73	1/2
10731	3/4	208-230	5.2	10/370	TEAO	Ball	6.50	6.23	1/2

MARS NO.	HP	VOLTS	AMPS	CAP REQ.	ENCL.	BRG.	DIMENSIONS		
							A	B	C
825 RPM									
10411	1/8	208-230	0.80	5/370	TEAO	Ball	6.50	4.13	1/2
10403	1/6	208-230	1.0	5/370	TEAO	Ball	6.50	4.23	1/2
10412	1/5	208-230	1.3	5/370	TEAO	Ball	6.50	4.40	1/2
10404	1/4	208-230	1.6	5/370	TEAO	Ball	6.50	4.48	1/2
10405	1/3	208-230	1.9	7.5/370	TEAO	Ball	6.50	5.23	1/2
10746	1/2	208-230	2.8	12.5/370	TEAO	Ball	6.50	5.70	1/2

Outdoor Condenser Fan Motors

Ball Bearing

MARS up/down outdoor condenser fan motors are designed for either vertical shaft-up or shaft-down applications. Shell and end shields are enclosed for weather protection. A weep hole is provided in each end shield to allow condensate to drain. All of these motors are suitable for air conditioning or heat pump applications.

Features:

- All angle
- Rheem mounting holes w/screws installed
- Water slinger on shaft
- Thru-bolt or band mounting
- Capacitor requirement noted on motor label
- Extra set of nuts & star washers on mounting studs
- Double full flattened shaft

Specifications:

- Class "B" insulation
- Single phase, 60 hertz
- Thermal overload protected
- Totally enclosed
- 36 inch leads
- UL Recognized

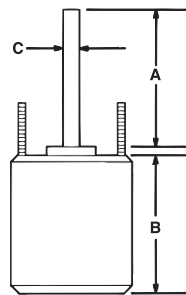

Outdoor Condenser Fan Motors - Shaft Up Only

MARS outdoor condenser fan motors are designed for shaft up only used in condenser fan and heat pump units requiring vertical shaft up positioning with "belly band" or extended clamp screw mounting.

Features:

- Rheem mounting holes w/screws installed
- For shaft up application
- Reversible rotation
- Water slinger on shaft
- Full flattened six inch shaft length
- Capacitor requirement noted on motor label

Specifications:

- Class "B" insulation
- Single phase, 60/50 Hertz
- Automatic thermal overload protected
- Fan duty, continuous, air over
- 36 inch leads
- Lead end endshield open construction
- UL Recognized

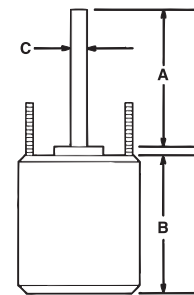

Reversible Rotation – Single Speed

MARS NO.	HP	VOLTS	AMPS	RPM	CAP REQ.	DIMENSIONS		
						A	B	C
1075 RPM								
10732	1/6	208-230	0.90	1075	5/370	6.50	4.13	1/2
10733	1/4	208-230	1.8	1075	5/370	6.50	4.25	1/2
10734	1/3	208-230	2.4	1075	7.5/370	6.50	5.10	1/2
10735	1/2	208-230	3.5	1075	10/370	6.50	5.70	1/2
10736	3/4	208-230	5.2	1075	10/370	6.50	5.11	1/2

MARS NO.	HP	VOLTS	AMPS	RPM	CAP REQ.	DIMENSIONS		
						A	B	C
825 RPM								
10203	1/6	208-230	1.0	825	5/370	5.50	4.10	1/2
10204	1/4	208-230	1.6	825	5/370	5.50	4.40	1/2
10205	1/3	208-230	1.9	825	7.5/370	5.50	5.10	1/2
10747	1/2	208-230	2.8	825	12.5/370	6.50	5.70	1/2

1075 RPM – Shaft-Up – Single Speed

MARS NO.	HP	VOLTS	AMPS	ROTATION	CAP REQ.	BRG.	DIMENSIONS		
							A	B	C
10327	1/6	208-230	0.9	REV	5/370	Sleeve	6.0	4.15	1/2
10328	1/4	208-230	1.8	REV	5/370	Sleeve	6.0	4.15	1/2
10329	1/3	208-230	2.4	REV	7.5/370	Sleeve	6.0	5.11	1/2
10330	1/2	208-230	3.5	REV	10/370	Ball	6.0	5.70	1/2
10331	3/4	208-230	5.2	REV	10/370	Sleeve	6.0	6.09	1/2

Condenser Fan Motors

MARS Three Wire Condenser Fan Motors

Ball Bearing

MARS 3 Wire condenser fan motors replicate OEM wiring for condenser fan motors speeding installation and saving time.

Condenser fan motors are designed for either shaft-up or shaft-down applications. End shields are enclosed for weather protection. A weep hole is provided in each end shield to allow condensate to drain. All of these motors are suitable for air conditioning or heat pump applications.

Features:

- All angle, ball bearing
- Rheem mounting holes w/screws installed
- Water slinger on shaft
- Thru bolt or band mounting
- Capacitor requirement noted on motor label
- Double full flattened shaft

Specifications:

- Class "B" insulation
- Single phase, 60 Hertz
- Thermal overload protected
- Fan duty, continuous, air over
- Totally enclosed
- 36 inch leads
- UL Recognized

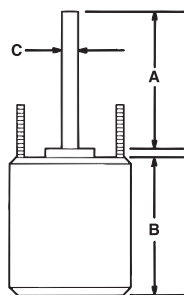

Outdoor Condenser Fan Motors

Ball Bearing - 70°C

MARS 70°C SunSlinger totally enclosed condenser fan motors are designed for either vertical shaft-up or shaft-down applications in a variety of ambient conditions. Shell and end shields are enclosed for weather protection. A weep hole is provided in each end shield to allow condensate to drain. All of these motors are suitable for air conditioning or heat pump applications.

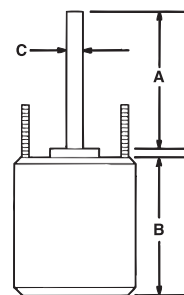

Features:

- All angle
- Rheem mounting holes w/screws installed
- Trane 4.33 bolt circle mounting holes with self tapping screws
- Thru bolt or band mounting
- Water slinger on shaft
- Capacitor requirement noted on motor label
- Extra set of nuts on mounting studs

Specifications:

- Class "B" insulation
- Single phase, 60 Hertz
- 70°C/158°F
- Thermal overload protected
- Fan duty, continuous, air over
- Totally enclosed
- 36 inch leads
- UL Recognized

Reversible Rotation – Single Speed – 3 Wire

MARS NO.	HP	VOLTS	AMPS	CAP REQ.	ENCL.	BRG.	DIMENSIONS		
							A	B	C
1075 RPM									
23728	1/4	208-230	1.8	5/370	TEAO	Ball	6.50	4.23	1/2
23729	1/3	208-230	2.4	7.5/370	TEAO	Ball	6.50	5.23	1/2

Reversible Rotation – Single Speed

MARS NO.	HP	VOLTS	AMPS	CAP REQ.	ENCL.	DIMENSIONS		
						A	B	C
1075 RPM								
20727	1/6	208-230	0.90	5/370	TEAO	6.50	4.25	1/2
20728	1/4	208-230	1.8	5/370	TEAO	6.50	4.72	1/2
20729	1/3	208-230	2.4	7.5/370	TEAO	6.50	5.24	1/2
20730	1/2	208-230	3.5	10/370	TEAO	6.50	5.91	1/2
20731	3/4	208-230	5.2	10/370	TEAO	6.50	5.90	1/2

MARS NO.	HP	VOLTS	AMPS	CAP REQ.	ENCL.	DIMENSIONS		
						A	B	C
825 RPM								
20402	1/8	208-230	0.75	5/370	TEAO	6.50	4.30	1/2
20403	1/6	208-230	1.0	5/370	TEAO	6.50	4.52	1/2
20404	1/4	208-230	2.2	5/370	TEAO	6.50	4.92	1/2
20405	1/3	208-230	1.9	7.5/370	TEAO	6.50	5.31	1/2
20746	1/2	208-230	2.8	12.5/370	TEAO	7.00	5.90	1/2

Outdoor Condenser Fan Motors

Ball Bearing - 80°C

MARS 80°C SunSlinger Max totally enclosed condenser fan replacement motors are designed for all major brands of HVAC equipment applications in a variety of ambient conditions. These 48 frame motors offer the highest performance and available from 1/6HP thru 3/4HP, 1075 RPM and 825 RPM, and 208-230V.

Features:

- All angle
- Rheem mounting holes w/screws installed
- Trane 4.33 bolt circle mounting holes with self tapping screws
- Thru bolt or belly band mounting
- Water slinger on shaft
- Capacitor requirement noted on motor label
- Extra set of nuts on mounting studs

Specifications:

- Class "F" insulation
- Single phase, 60 Hz
- 80°C (176°F) max ambient
- Thermal overload protection
- Fan duty, continuous, air over
- Totally enclosed
- 36 inch leads
- UL Recognized

Reversible Rotation

MARS NO.	HP	VOLTS	AMPS	RPM	CAP REQ.	ENCL.	DIMENSIONS		
							A	B	C
1075 RPM									
20791	3/4	208-230	4.5	1075	10/370	TEAO	6.50	6.50	1/2
825 RPM									
20796	1/2	208-230	2.8	825	12.5/370	TEAO	7.00	6.42	1/2

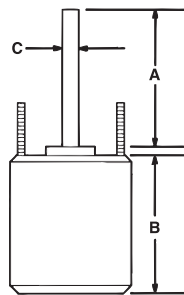

Multi-Horsepower Condenser Fan Motors

Ball Bearing

MARS multi-horsepower condenser fan motors are ideal for truck stock. Three 1075 RPM models cover 208-230 volt applications from 1/6 to 1/2 HP. Two 825 RPM models cover 208-230 volt applications from 1/8 to 1/3 HP.

Features:

- Rheem mounting holes w/screws installed
- Thru bolt or band mounting
- Water slinger on shaft
- Air conditioning or heat pump duty

Specifications:

- Class "B" insulation
- Single phase, 60 Hz
- Thermal overload protected
- UL Recognized

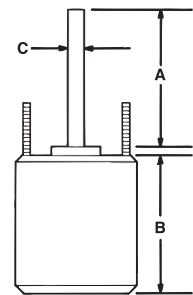

The Wiz

MARS NO.	HP	ROT	RPM/SP.	VOLTS	ENCL.	BRG.	DIMENSIONS			LEAD LENGTHS
							A	B	C	
10458	1/6 - 1/3	Rev	1075	208-230	TEAO	Ball	6.50	4.52	1/2	36"
10459	1/8 - 1/3	Rev	825	208-230	TEAO	Ball	6.50	5.48	1/2	36"
10465	1/6 - 1/3	Rev	1075/2	208-230	TEAO	Ball	5.00	4.73	1/2	38"
10468	1/5 - 1/2	Rev	1075/2	208-230	TEAO	Ball	5.00	5.48	1/2	38"
10469	1/6 - 1/3	Rev	825/2	208-230	TEAO	Ball	5.00	5.48	1/2	42"

Condenser Fan Motors

Multi-Horsepower Condenser Fan Motors

Ball Bearing - 70°C

MARS 70°C multi-horsepower SunSlinger condenser fan motors are ideal for truck stock. They are designed to provide reliable operation in a wide range of ambient temperatures. Three 1075 RPM models cover 208-230 volt applications from 1/6 to 1/2 HP. Two 825 RPM models cover 208-230 volt applications from 1/8 to 1/3 HP.

Features:

- All angle
- Rheem shell mounting holes with screws installed
- Trane 4.33 bolt circle mounting holes with self tapping screws
- Thru bolt or band mounting
- Water slinger on shaft
- Extra set of nuts on mounting studs

Specifications:

- Class "B" insulation
- Single phase, 60 Hertz
- 70°C/158°F
- 36 inch leads
- Thermal overload protected
- Fan duty, continuous, air over
- Totally enclosed
- UL Recognized

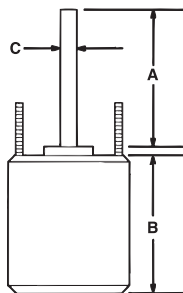

20458 & 20459:

- Short shell length
- Just ONE capacitor rating per motor
- Quick & Simple 2 wire installation

MARS 460V Outdoor Condenser Fan Motors

Ball Bearing - 70°C

MARS 70°C SunSlinger totally enclosed outdoor condenser fan motors are designed for all angle air conditioning or heat pump applications. A weep hole is provided in each end shield to allow condensate to drain.

Features:

- All angle
- Rheem mounting holes w/screws installed
- Trane 4.33 bolt circle mounting holes and self tapping screws
- Extended thru bolt or band mounting and extra nuts
- Capacitor requirement noted on motor label
- Water slinger on shaft
- End shield drain holes w/plugs

Specifications:

- Single phase, 60 Hz
- 70°C/158°F
- Thermal overload protected
- Totally enclosed
- 48 inch leads, Multi-HP
- 36 inch leads
- UL Recognized

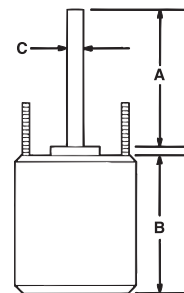

Multi-Horsepower – Reversible Rotation

MARS NO.	HP	RPM/SPDS	VOLTS	AMPS	CAP REQ.	ENCL.	BRG.	DIMENSIONS		
								A	B	C
20458	1/6-1/3	1075	208-230	2.8	7.5/370	TEAO	Ball	6.50	5.00	1/2
20459	1/8-1/3	825	208-230	1.9	10/370	TEAO	Ball	6.50	5.71	1/2
20465	1/6-1/3	1075/2	208-230	2.5	5/7.5/370	TEAO	Ball	7.00	5.16	1/2
20468	1/5-1/2	1075/2	208-230	3.6	10/12.5/370	TEAO	Ball	5.00	6.10	1/2
20469	1/6-1/3	825/2	208-230	1.9	10/7.5/370	TEAO	Ball	5.00	6.10	1/2

One-On-One™ Replacement Motors

MARS NO.	HP	ROT	RPM/SPDS	VOLTS	AMPS	CAP REQ.	ENCL.	BRG.	DIMENSIONS		
									A	B	C
Emerson 5462H											
20462	1/3, 1/4, 1/5, 1/6	REV	1075/2	208-230	2.0	5/7.5/370	TEAO	Ball	5.00	4.91	1/2
Emerson 5482H											
20471	1/4, 1/3, 1/2, 3/4	REV	1075/2	208-230	4.2/3.6	15/440	TEAO	Ball	5.5	6.5	1/2
AO Smith FE6003F											
20470	1/4, 1/2	REV	825/2	208-230	2.6	10/12.5/440	TEAO	Ball	6.5	6.1	1/2
AO Smith ORM5458BF											
20457	1/8, 1/10, 1/12, 1/15	REV	825/1	208-230	0.75	5/440	TEAO	Ball	6.5	4.7	1/2
AO Smith ORM5454BF											
20463	1/8 - 1/15	REV	1075/1	208-230	0.65	5/440	TEAO	Ball	6.5	4.4	1/2

Reversible Rotation

MARS NO.	HP	VOLTS	AMPS	RPM	CAP REQ.	DIMENSIONS					
						A	B	C			
1075 RPM - Single Speed											
20835	1/6	460	0.48	1075	5/440	6.50	4.32	1/2			
20836	1/4	460	0.65	1075	7.5/440	6.50	4.52	1/2			
20837	1/3	460	0.90	1075	7.5/440	6.50	5.38	1/2			
20838	1/2	460	1.3	1075	10/440	6.50	5.86	1/2			
20842	3/4	460	2.0	1075	10/440	6.50	6.29	1/2			
825 RPM - Single Speed											
20859*	1/6	460	0.53	825	5/440	3.22	4.52	1/2			
20880	1/4	460	0.90	825	5/440	6.50	5.00	1/2			
20881	1/3	460	1.0	825	7.5/440	6.50	5.62	1/2			
20882	1/2	460	1.55	825	10/440	6.50	6.34	1/2			
1075 RPM - Multi-HP											
20478	1/3 - 1/6	460	1.2	1075	7.5/370	6.50	4.90	1/2			
20479	1/2 - 1/5	460	1.5	1075	10/370	6.50	5.60	1/2			
20480	1/2 - 1/6	460	1.46	1075	10/440	5.50	5.70	1/2			
20481	3/4 - 1/4	460	2.12	1075	15/440	5.50	6.48	1/2			
One-On-One™ Replacement Motor for AO Smith ORM4688BF											
MARS NO.	HP	ROT	RPM/SPDS	VOLTS	AMPS	CAP REQ.	ENCL.	BRG.	DIMENSIONS		
20884	1/8, 1/6, 1/5, 1/4, 1/3	REV	825/1	460	1.0	7.5/370	TEAO	Ball	6.50	5.3	1/2

* CW Rotation-opposite shaft end

MARS 460V Outdoor Condenser Fan Motors – Shaft Up Only

Ball Bearing - 70°C

MARS 70°C SunSlinger totally enclosed outdoor condenser fan motors are designed for Shaft Up Only. All of these motors are suitable for air conditioning or heat pump applications. A weep hole is provided in each end shield to allow condensate to drain.

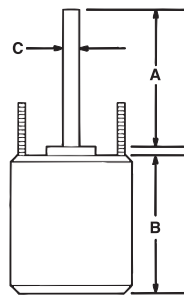

Features:

- Shaft up only
- Rheem mounting holes w/screws installed
- Extended thru bolt or band mounting
- Capacitor requirement noted on motor label

Specifications:

- Single Phase, 60 Hz
- 70°C/158°F
- Thermal overload protected
- Totally enclosed
- UL Recognized

Reversible Rotation

MARS NO.	HP	VOLTS	AMPS	CAP REQ.	DIMENSIONS			LEAD LENGTHS
					A	B	C	
1075 RPM								
20846	1/4	460	0.65	7.5/440	6.50	4.60	1/2	36"
20847	1/3	460	0.90	7.5/440	6.50	5.50	1/2	36"
20848	1/2	460	1.3	10/440	6.50	5.90	1/2	36"
20849	3/4	460	2.05	10/440	7.00	6.20	1/2	47"

Super-Fit™ Multi-Horsepower Condenser 42 Frame Fan Motors

Ball Bearing

MARS 42 frame Super-Fit™ multi-horsepower condenser fan motors are ideal for truck stock. Two models cover 208-230V applications from 1/12 HP through 1/4 HP replacing many AOS, Westinghouse, Fasco, Emerson and GE motor designs.

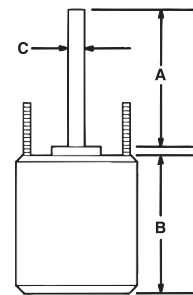

Features:

- Super-Fit™ mounting holes for Trane 4.33, 4.42 and 4.62 bolt circle mounting. Includes self threading screws.
- All angle mount
- Reversible rotation
- Multi-HP
- Capacitor requirement noted on motor label
- 1/2 inch dia. flatted shaft
- Totally enclosed

Specifications:

- Class "B" insulation
- 42 frame
- Single phase, 60 Hz
- Continuous air over
- Thermal overload protected
- Continuous duty
- 36 inch leads
- UL Recognized

Reversible Rotation – Single Speed

MARS NO.	HP	VOLTS	AMPS	RMP	CAP	ENCL.	BRG.	DIMENSIONS		
								A	B	C
10722	1/8, 1/10, 1/12	208-230	0.75	1075	5/370	TEAO	Ball	3.00	4.13	1/2
10723	1/4, 1/5, 1/6	208-230	1.5	1075	7.5/370	TEAO	Ball	3.00	4.72	1/2
10724	1/4, 1/5, 1/6	208-230	1.35	1625	5/370	TEAO	Ball	3.00	4.60	1/2

Direct Drive Blower Motors

Direct Drive Blower Motors

MARS direct drive furnace blower motors are three speed standard efficiency models. All models are electrically reversible and include 2-1/4 inch resilient rings for base mounting. These models have all angle sleeve bearings and have open air over enclosures.

Features:

- Sleeve bearing
- Rheem mounting holes
- 3 speeds
- 1/2 inch extended thru bolts
- 2-1/4 inch resilient rings
- For accessories see pages M-44 – M-46

Specifications:

- Class "B" insulation
- Single phase, 60 Hertz
- Thermal overload protected
- Fan duty, continuous, air over
- Open construction
- 36 inch leads
- UL Recognized

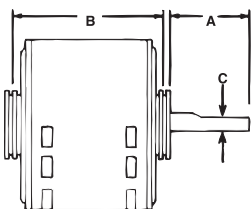

High Efficiency Direct Drive Blower Motors – MARS Energy Master

Ball Bearing

MARS High Efficiency direct drive blower motors save ENERGY. Designed for continuous air over applications, such as furnace blowers or central air handling units with single shaft requirements.

Features:

- Optimized high efficiency design
- 12-15% more efficient compared to standard motors
- Permanently lubricated ball bearings
- Rheem mounting holes
- Extended thru bolts, shaft end
- 3 Speeds
- Open Construction
- 2-1/4 resilient rings - plus 2-1/2 split rings included

Specifications:

- Class "B" insulation
- Single phase, 60 Hertz
- Fan duty, continuous air over
- Automatic thermal overload protection
- 36 inch leads
- UL Recognized

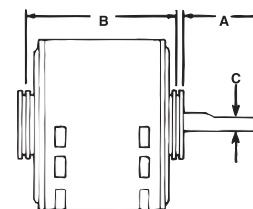

1075 RPM – Three Speed – Reversible Rotation

MARS NO.	HP	ROT	VOLTS	AMPS	CAP REQ.	ENCL.	BRG.	DIMENSIONS		
								A	B	C
10583	1/4	Rev	115	4.2	5/370	OAO	Slv	4.50	4.89	1/2
10584	1/4	Rev	208-230	1.8	5/370	OAO	Slv	4.50	4.89	1/2
10585	1/3	Rev	115	6.1	5/370	OAO	Slv	4.50	5.14	1/2
10586	1/3	Rev	208-230	2.7	5/370	OAO	Slv	4.50	5.14	1/2
10587	1/2	Rev	115	7.5	10/370	OAO	Slv	4.50	5.89	1/2
10588	1/2	Rev	208-230	3.2	7.5/370	OAO	Slv	4.50	5.64	1/2
10589	3/4	Rev	115	11.2	15/370	OAO	Slv	4.50	6.14	1/2
10590	3/4	Rev	208-230	4.5	10/370	OAO	Slv	4.50	6.14	1/2
10591	1	Rev	115	11.8	20/370	OAO	Ball	4.50	5.80	1/2
10592	1	Rev	208-230	5.6	15/370	OAO	Ball	4.50	5.80	1/2

1075 RPM – Reversible Rotation

MARS NO.	HP	VOLTS	AMPS	CAP REQ.	ENCL.	BRG.	DIMENSIONS		
							A	B	C
10573	1/4	115	2.9	7.5/370	OPAO	Ball	4.50	4.07	1/2
10574	1/4	208-230	1.3	5/370	OPAO	Ball	4.50	4.07	1/2
10575	1/3	115	3.9	10/370	OPAO	Ball	4.50	4.58	1/2
10576	1/3	208-230	1.6	7.5/370	OPAO	Ball	4.50	4.58	1/2
10577	1/2	115	5.2	15/370	OPAO	Ball	4.50	5.28	1/2
10578	1/2	208-230	2.5	10/370	OPAO	Ball	4.50	5.28	1/2
10579	3/4	115	8.0	20/370	OPAO	Ball	4.50	5.60	1/2
10580	3/4	208-230	3.5	15/370	OPAO	Ball	4.50	5.60	1/2

MARS 48 Frame Torsion Flex Mount Motors

MARS torsion flex mount motors are designed for direct drive furnace blower applications. The unique torsion flex mounting speeds installation while the special steel of the torsion flex bracket absorbs vibration for quieter operations. All models are electrically reversible, 3 speed motors.

Features:

- Sleeve bearing
- Torsion flex mount
- 3 speeds
- 4-1/2 inch long, 1/2 inch diameter shaft
- Torsion mount sleeves and grommets included

Specifications:

- Class "B" insulation
- Single phase, 60 Hertz
- Thermal overload protected
- Fan duty, continuous, air over
- Open construction
- 36 inch leads
- UL Recognized

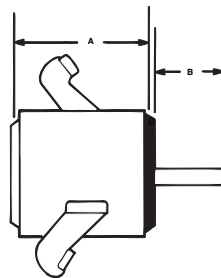

Multi-Horsepower Direct Drive Blower Motors

MARS multi-horsepower direct drive blower motors are ideal for truck stock. Four models cover both 115 volt and 208-230 volt applications from 1/6 through 3/4 HP. All MARS multi-horsepower motors feature Rheem shell mounting holes.

Features:

- Rheem mounting holes
- 2-1/4 inch resilient rings

Specifications:

- Class "B" insulation
- Single phase, 60 Hz
- Thermal overload protected
- 36 & 41 inch leads
- UL Recognized

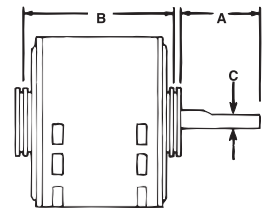

Four Speed

MARS NO.	HP	ROT	VOLTS	RPM	ENCL.	BRG.	DIMENSIONS			LEAD LENGTHS
							A	B	C	
10463	1/6 - 1/2	Rev	115	1075	OAO	Slv	5.50	4.73	1/2	41"
10464	1/6 - 1/2	Rev	208-230	1075	OAO	Slv	5.50	4.73	1/2	41"
10466	1/5 - 3/4	Rev	115	1075	OAO	Ball	5.80	5.73	1/2	41"
10467	1/5 - 3/4	Rev	208-230	1075	OAO	Ball	5.60	5.23	1/2	41"
10479	1/8 - 1/3	Rev	208-230	825	OAO	Slv	4.50	5.30	1/2	36"

1075 RPM – Three Speed – Reversible Rotation

MARS NO.	HP	ROTATION	VOLTS	AMPS	CAP REQ.	ENCL.	BRG.	DIMENSIONS		
								A	B	C
10683	1/4	REV	115	4.2	5/370	OAO	SLV	4.50	4.89	1/2
10684	1/4	REV	208-230	1.8	5/370	OAO	SLV	4.50	4.89	1/2
10685	1/3	REV	115	6.1	5/370	OAO	SLV	4.50	5.14	1/2
10686	1/3	REV	208-230	2.7	5/370	OAO	SLV	4.50	5.14	1/2
10687	1/2	REV	115	7.5	10/370	OAO	SLV	4.50	5.89	1/2
10688	1/2	REV	208-230	3.2	7.5/370	OAO	SLV	4.50	5.64	1/2
10689	3/4	REV	115	11.2	15/370	OAO	SLV	4.50	6.14	1/2
10690	3/4	REV	208-230	4.5	10/370	OAO	SLV	4.50	6.14	1/2

MARS 460V Direct Drive Blower Motors

Ball Bearing

MARS direct drive blower motors are installed in residential and commercial furnaces, air conditioners, exhaust fans, and other air handling equipment.

Features:

- All angle
- 2 speeds
- Extended studs
- 2-1/4 inch resilient rings

Specifications:

- Class "B" insulation
- Single phase, 60 Hz
- Thermal overload protected
- 36 inch leads
- UL Recognized



Reversible Rotation

MARS NO.	HP	VOLTS	AMPS	CAP REQ.	ENCL.	BRG.	DIMENSIONS		
							A	B	C
20538	1/2	460	1.8	10/370	OAO	Ball	6.50	5.25	1/2

1075 RPM - Two Speed

Multi-Horsepower – Reversible Rotation

MARS NO.	HP	VOLTS	AMPS	CAP REQ.	ENCL.	BRG.	DIMENSIONS		
							A	B	C
20580	1/3 - 1/4	460	0.95	7.5/370	OAO	Ball	6.50	4.50	1/2
20581	3/4 - 1/2	460	2.1	15/370	OAO	Ball	4.50	5.80	1/2

See diagram above for dimensions

Fan & Blower Motors

Belted Fan & Blower Motors

Ball Bearing

MARS belted blower motors are designed to meet manufacturer's requirements for belted fan or blowers.

Features:

- Resilient base mounted
- Single speed
- Slotted holes in base match 48 or 56 frame bolt patterns
- 1/2 inch shaft diameter

Specifications:

- Class "B" insulation
- Single phase, 60 Hz
- Thermal overload protected
- Open construction
- Continuous duty
- UL Recognized

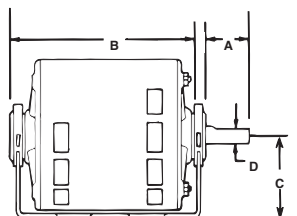

1725 RPM – Single Speed – Reversible Rotation

MARS NO.	HP	VOLTS	FLA	SF	DIMENSIONS				NEMA FRAME
					A	B	C	D	
10401	1/4	115	4.3	1.35	1.85	6.25	3.00	1/2	48/56
10406	1/3	115	5.8	1.35	1.85	6.25	3.00	1/2	48/56
10408	1/2	115	7.7	1.25	1.85	6.88	3.00	1/2	48/56

Tech Tip

When replacing a blower or fan motor, inspect the blower wheel or fan and replace or clean as necessary to optimize performance.

Belted Fan & Blower Motors, Split Phase

Ball Bearing

MARS belted blower motors are designed to meet manufacturer's requirements for belted fan or blowers.

Features:

- Single speed, split phase
- 48/56 frame mounting holes
- Heavy gauge steel construction frame and base
- 1/2" x 1-7/8" Shaft with 1-5/8" Flat
- Extended thru bolts

Specifications:

- Class "B" insulation
- Single phase, 60 Hz
- Continuous duty
- Automatic thermal overload protection, as noted
- cULus

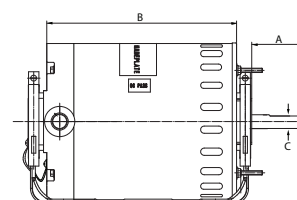
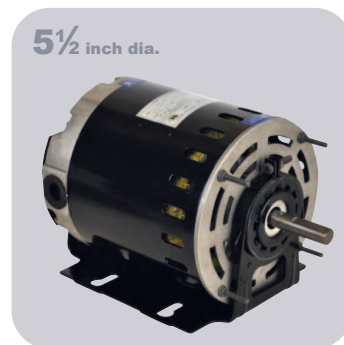

Cross Reference:

MARS No.	AO Smith/ Century	Baldor	Emerson/ US Motors	Genteq	Magnetek	Marathon
10302	919L	-	DB14B2N4Z	-	919	B302
10303	920L, GF2024	RSP1441A	8000, 3618	4701, 4730	808	B303, B206
10304	921L, RB2034L	-	D13B2N4Z9	-	921	B304
10305	922L, RB2034	-	8100, PD6004	-	922	B305, B207
10306	-	-	D12C2J49	-	-	B306
10307	GF2054	RSP3451A	8200, PD6006	4708, 4733	-	B307

1725 RPM - Reversible - Dripproof

MARS NO.	HP	VOLTS	AMPS	S.F	ENCL.	BRG.	NEMA FRAME	DIMENSIONS		
								A	B	C
10303*	1/4	115	4.3	1.35	DP	Ball	48Y	1.85	6.25	1/2
10305*	1/3	115	5.8	1.35	DP	Ball	48Y	1.85	6.25	1/2
10307*	1/2	115	7.7	1.25	DP	Ball	48Y	1.85	6.88	1/2
10302	1/4	115	4.3	1.35	DP	Ball	48Y	1.85	6.25	1/2
10304	1/3	115	5.8	1.35	DP	Ball	48Y	1.85	6.25	1/2
10306	1/2	115	5.8	1.35	DP	Ball	48Y	1.85	6.88	1/2

* Automatic Thermal Overload Protection

Fan & Blower Motors, Capacitor Start

Ball Bearing

MARS fan & blower motors are designed for applications like commercial fans and blowers, direct and belt drive air handlers and exhaust fans.

Features:

- Single speed, capacitor start
- 48/56 frame mounting holes
- Heavy gauge steel construction frame and base
- 5/8" Shaft dia. with keyway
- Extended thru bolts

Specifications:

- Class "B" insulation
- Single phase, 60 Hz
- Continuous duty
- Automatic thermal overload Protection, as noted
- cULus

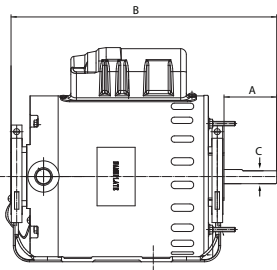

Cross Reference:

MARS No.	AO Smith/ Century	Baldor	Emerson/ US Motors	Fasco	Leeson	Magnetek	Marathon
10313	C196L	RL1203A	D12CPA2P49	-	100109.00	C196	B313
10315	RBF1034A	-	180	-	-	-	B315
10317	BK1054, C412V1	-	D12CPA2PH9	D6084	100011.00	-	B317
10319	C426V1, RB1074A	RL1307A	1893	-	100012.00	-	B319
10321	C523V1	RL1310A	D1CPA2PH9	D6088	110007.00	-	4688

1725 RPM - Reversible - Dripproof

MARS NO.	HP	VOLTS	AMPS	S.F	ENCL.	BRG.	NEMA FRAME	DIMENSIONS		
								A	B	C
10313	1/4	115/208-230	5.0/2.4-2.5	1.35	DP	Ball	48YZ	1.85	10.30	1/2
10315	1/3	115/208-230	5.4/2.6-2.7	1.35	DP	Ball	48Z	1.93	10.22	1/2
10317	1/2	115/208-230	8.0/4.1-4.0	1.25	DP	Ball	56	1.93	10.41	5/8
10319	3/4	115/208-230	10.0/5.2-5.0	1.25	DP	Ball	56	1.93	11.00	5/8
10321	1	115/208-230	14.4/7.2-7.2	1.00	DP	Ball	56	1.95	11.26	5/8

Commercial Condenser Fan Motors, Rigid Base, 3 Phase

Ball Bearing

MARS Commercial condenser fan motors may be installed outdoors. These motors need to be mounted within the airflow of the fan for proper cooling. 56Z or 56HZ rigid base is easy to remove and provides mounting flexibility. Use on Trane, Carrier, Climatrol and York units, 5 tons and larger.

Features:

- 70°C ambient except as noted
- VFD Compatible
- Water slinger on shaft
- Rigid Base - Horizontal or Vertical mounting
- Enclosed shaft end bracket, vented frame
- Flat and keyway on shaft

Specifications:

- Class "H1" insulation
- Three Phase, 60/50 Hz
- Continuous duty, air over
- Automatic thermal overload protected
- cULus

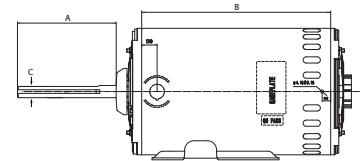
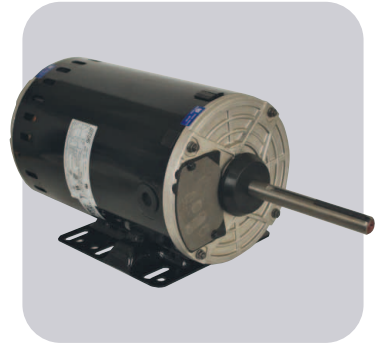

Cross Reference:

MARS No.	AO Smith/ Century	Baldor	Emerson/ US Motors	Leeson	Marathon
10513	H1050A	-	1820H, 1820V	-	X513
10523	H1051A	CFM3166A	1821H, 1821V	111148	X523
10531	H1054A	-	1831H, 1831V, 1100	-	X531

MARS NO.	HP	VOLTS	AMPS	S.F	ENCL.	BRG.	NEMA FRAME	DIMENSIONS		
								A	B	C

1140 RPM - Reversible - Three Phase

10533*	1/2	208-230/460	2.1-2.0/1.0	1.0	OPAO	Ball	56Z	5.50	7.14	5/8
10513	1	208-230/460	4.1-4.5/2.3	1.0	OPAO	Ball	56HZ	5.00	7.66	5/8
10523	1-1/2	208-230/460	5.7-5.8/2.9	1.0	OPAO	Ball	56HZ	5.00	8.45	5/8

850 RPM - Reversible - Three Phase

10531	1-1/2	208-230/460	6.5-6.7/3.4	1.0	OPAO	Ball	56HZ	5.00	9.23	5/8
-------	-------	-------------	-------------	-----	------	------	------	------	------	-----

* 60 Deg C

Commercial Condenser Fan Motors / Heating Motors

Commercial Condenser Fan Motors, Belly Band, 3 Phase

Ball Bearing

MARS Commercial condenser fan motors may be installed outdoors. These motors need to be mounted within the airflow of the fan for proper cooling. Use on Trane, Carrier, Climatrol and York units, 5 tons and larger.

Features:

- 70°C ambient
- VFD Compatible, except 575V
- Water slinger on shaft
- Four locating screws 90° apart, 3-3/8" from outer edge of shaft slinger
- Enclosed shaft end bracket, vented frame
- Flat and keyway on shaft
- Belly Band and Resilient Ring Mounting

Specifications:

- Class "H1" insulation
- Three Phase, 60/50 Hz, 575V - 60 Hz only
- Continuous duty, air over
- Automatic thermal overload protected
- cULus

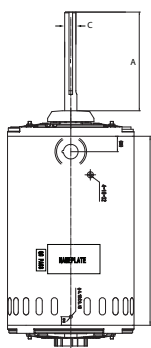

Unit Heater Motors, PSC

Ball Bearing

MARS replacement unit heater motors need to be mounted within the airstream for proper cooling.

Features:

- Totally enclosed, air over
- Horizontal or vertical mount
- 1" extended thru-bolts
- Reversing plug
- BX connector mounted in frame

Specifications:

- Class "B" insulation
- Single phase, 60 Hz
- Continuous duty
- Automatic reset thermal overload
- 37 inch leads
- cULus

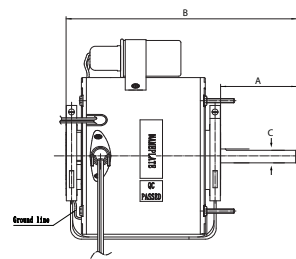

Cross Reference:

MARS No.	AO Smith/ Century	Emerson/ US Motors	Marathon
30301	UH1016, US1016	1386	X302
30303	566A, UH1026	1384	X303
30305	UH1036	1388	X304

Cross Reference:

MARS No.	AO Smith/ Century	Baldor	Emerson/ US Motors	Fasco	Magnetek	Marathon
10502	FC3106F	CFM3156A	1818H	-	H667	X502
10503	H1051A	CFM3166A	1819H	D6610	H767	X503
10507	H1053A	-	1828H, 1828V	-	H686	X507
10509	H698	-	8987V	-	-	X509
10530	H1054A, H1053A	-	1832H, 1832V	-	-	X530

1075 RPM - Reversible

MARS NO.	HP	VOLTS	AMPS	CAPACITOR INCLUDED	ENCL. BRG.	NEMA FRAME	DIMENSIONS			
							A	B	C	
30301	1/6	115	3.0	5/370	TEAO	Ball	48Y	2.75	8.25	1/2
30303	1/4	115	4.1	7.5/370	TEAO	Ball	48Y	2.75	8.25	1/2
30305	1/3	115	6.5	7.5/370	TEAO	Ball	48Y	2.75	9.70	1/2

MARS NO.	HP	VOLTS	AMPS	S.F	ENCL.	BRG.	NEMA FRAME	DIMENSIONS		
								A	B	C

1140 RPM - Reversible - Three Phase

10502	1	208-230/460	4.18-4.38/2.19	1.0	OPAO	Ball	56Y	5.00	7.66	5/8
10503	1-1/2	208-230/460	5.3-5.09/2.55	1.0	OPAO	Ball	56Y	5.00	8.84	5/8
10509	2	208-230/460	7.3-7.0/3.7	1.0	OPAO	Ball	56Y	5.00	9.62	5/8

850 RPM - Reversible - Three Phase

10507	1	208-230/460	5.1-5.1/2.53	1.0	OPAO	Ball	56Y	5.00	8.84	5/8
10530	1-1/2	208-230/460	7.05-6.7/3.57	1.0	OPAO	Ball	56Y	5.00	9.62	5/8

MARS Oil Burner Motors

Ball Bearing

MARS Oil Burner Motors are replacement motors for residential and commercial oil burners, hot water pressure/steam cleaners and other applications where 48M or 48N flange mounting is required.

Features:

- All angle
- Split Phase and PSC
- Semi or totally enclosed
- Two bolt direct mounting for 48M and 48N

Specifications:

- Class "B" insulation
- Single phase, 60 Hertz
- Continuous duty
- Manual reset overload protection
- Auto reset protection for PSC
- cULus

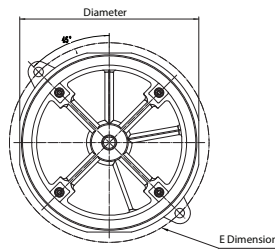

Cross Reference:

MARS No.	AO Smith/ Century	Beckett	Emerson/ US Motors	Marathon
30004	EL2022	-	2302	O004
30011	OI2052D	-	3267	O011
30100	EL2002	-	3083	O100
30600	EL2005	-	3196	O600
30601	XEL2014	-	3252	O601
30701	-	21805U	3274	O701

MARS NO.	DIA.	HP	RPM/ SPD	VOLTS	AMPS	ROT.	FRAME	ENCL.	S.F.	SHAFT LGTH	SHAFT DIA.	E DIM.
----------	------	----	----------	-------	------	------	-------	-------	------	------------	------------	--------

Split Phase

30100	5-1/2	1/7	3450/1	115	2.4	Rev	48M	Semi Enclosed	1.0	1-3/4	1/2	6-3/4
30600	6-1/2	1/8	1725/1	115	2.7	Rev	48N	TENV	1.0	1-3/4	1/2	7-1/4
30601	6-1/2	1/6	1725/1	115	2.8	Rev	48N	TENV	1.0	1-3/4	1/2	6-1/2
30004	6-1/2	1/4	3450/1	115	3.8	Rev	48N	Semi Enclosed	1.0	1-13/16	1/2	7-1/4

Oil Burner, PSC

30701	5-1/2	1/7	3450/1	115	1.5	CCW SE	-	Semi Enclosed	-	1-3/4	1/2	5-1/4
30011	6-1/2	1/2	3450/1	115/208-230	8.2/4.1	Rev	48N	Semi Enclosed	1.0	1-3/4	1/2	7-1/4

51 Frame Unit Bearing Cast Iron Motors

MARS 51 frame motors are used on refrigerators, freezers, food & beverage coolers, vending machines, display cases, and many other fan duty applications.

Features:

- Cast iron construction
- Packed with vibration dampener, speed nut & screws
- Shaded pole, single phase
- Fan duty, continuous, air over
- Impedance protected
- For accessories see pages M-44 – M-46
- Class "A" insulation
- 60/50 Hertz

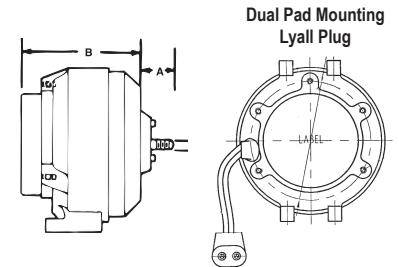

MARS NO.	WATTS	ROT OSE	VOLTS	AMPS	LEAD LENGTH	DIMENSIONS		
						A	B	C

1550 RPM—1/4-20 Threaded Shaft - Dual Pad Mounting - Lyall Plug

05211 ⁽¹⁾	4	CW	115	0.33	24"	0.66	2.64	1/4
05212 ⁽¹⁾	4	CCW	115	0.33	24"	0.66	2.64	1/4
05221 ⁽¹⁾	4	CW	230	0.19	24"	0.66	2.64	1/4
05222 ⁽¹⁾	4	CCW	230	0.19	24"	0.66	2.64	1/4
05311	6	CW	115	0.46	24"	0.66	3.14	1/4
05312	6	CCW	115	0.46	24"	0.66	3.14	1/4
05411	9	CW	115	0.62	24"	0.66	3.14	1/4
05412	9	CCW	115	0.62	24"	0.66	3.14	1/4
05421	9	CW	230	0.33	24"	0.66	3.14	1/4
05422	9	CCW	230	0.33	24"	0.66	3.14	1/4
05811 ⁽²⁾	16	CW	115	0.95	24"	0.66	3.34	1/4
05812 ⁽²⁾	16	CCW	115	0.95	24"	0.66	3.34	1/4
05821 ⁽²⁾	16	CW	230	0.48	24"	0.66	3.34	1/4
05822 ⁽²⁾	16	CCW	230	0.48	24"	0.66	3.34	1/4

1500 RPM—Smooth Shaft

05521 ⁽²⁾	50	CW	230	0.85	22"	1.50	4.50	3/8
----------------------	----	----	-----	------	-----	------	------	-----

(1) Class A Insulation

(2) Automatic Reset Overload Protection

Unit Bearing Motors / C-Frame Motors

51 Frame Unit Bearing Aluminum Motors

MARS aluminum 51 frame motors are economical replacements for cast iron motors. They feature an improved oiling system and class B insulation for longer life.

Features:

- Aluminum construction
- Unit bearing design
- Packed with vibration dampener, speed nut & screws
- Shaded pole, single phase
- Fan duty, continuous, air over
- Impedance protected
- For accessories see pages M-44 – M-46
- Class "B" insulation
- 60/50 Hertz

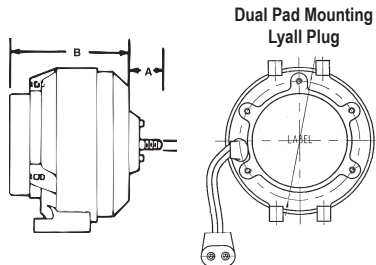

MARS NO.	WATTS	ROT OSE	VOLTS	AMPS	LEAD LENGTH	DIMENSIONS		
						A	B	C
1550 RPM—1/4-20 Threaded Shaft - Dual Pad Mounting - Lyall Plug								
05213 ⁽¹⁾	4	CW	115	0.33	24"	0.66	2.64	1/4
05223 ⁽¹⁾	4	CW	230	0.19	24"	0.66	2.64	1/4
05313	6	CW	115	0.46	24"	0.66	3.14	1/4
05413	9	CW	115	0.62	24"	0.66	3.14	1/4
05414	9	CCW	115	0.62	24"	0.66	3.14	1/4
05423	9	CW	230	0.33	24"	0.66	3.14	1/4
05813 ⁽¹⁾⁽²⁾	16	CW	115	0.95	24"	0.66	3.34	1/4
05814 ⁽¹⁾⁽²⁾	16	CCW	115	0.95	24"	0.66	3.34	1/4
05823 ⁽¹⁾⁽²⁾	16	CW	230	0.48	24"	0.66	3.34	1/4

(1) Class B Insulation
 (2) Automatic Reset Overload Protection

Super-Fit™ 3000 RPM Replacement Motor*

The MARS 90999 Super-Fit™ replacement fan motor is designed to replace virtually any refrigerator evaporator fan motor.

The MARS 90999 motor incorporates a unique new system which duplicates any OEM mounting quickly and easily. The rotor is reversible in the field for either clockwise or counterclockwise rotation.

In addition the MARS 90999 motor has the power to perform in even the largest refrigerators.

The MARS 90999 Super-Fit™ motor comes complete with mounting accessories and hardware.

*U.S. Patent

Features:

- Reversible rotation
- Duplicates any OEM motor
- Break-off shaft
- Easy-to-use, fewer parts to assemble than competitive motors
- Stock one motor - save on inventory
- Complete with accessories and instructions

Specifications:

- Electrical rating: 90999, 115V, 50/60 Hertz
- Overload protection: impedance protected
- Speed: 3000 RPM
- Shaft: 1/8 inch diameter with adaptors for 3/16 inch and hubless fans

MARS NO.	DESCRIPTION	VOLTS
90999	"Super-Fit" motor with accessories	115V, 50/60 Hz

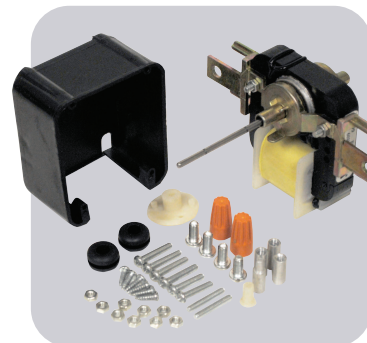

Replaces these popular motors... and hundreds more!

WHIRLPOOL/COLDSLOT

FRIGIDAIRE

GIBSON

WESTINGHOUSE

PHILCO

Super-Fit™ 3000 RPM Commercial Replacement Motor*

MARS 90970 Super-Fit™ commercial evaporator fan motor is the most versatile, easy-to-use, heavy-duty replacement evaporator fan motor available.

MARS 90970 is the first motor of this type with a dual voltage coil so you can stock one motor for both 115 volt and 230 volt applications. The unique system of slide locator screws lets you match OEM mountings quickly and easily.

The reversible 90970 features rugged, die cast bearing housings with self-aligning bearings and generous oil reservoir. The break-off shaft has adaptors to fit 1/8, 3/16, 1/4, 5/16 inch bores and hubless fan blades.

Each kit includes: Motor, 5.5" white plastic blade, accessory package.

*U.S. Patent



MARS 90970 Replaces:

ACME MIAMI	GEM	UNI-LINE ROBERT SHAW
750	EM675 EM680	14011
7502	EM675 EM683	14019
780		

Features:

- Dual voltage coil, 110-120/208-240 VAC
- 50/60 Hertz
- Mechanically reversible

Specifications:

- Electrical: 110-120/208-240 VAC; 50/60 Hertz
- Protection: thermal overload protected
- HP: 1/50
- RPM: 3000

3000 RPM – Mechanically Reversible

MARS NO.	HP	AMPS	STACK HT. IN.	SHAFT	VOLTS
90970	1/50	1.33	.75	2.174 X .1875	110-120/208-240

Super-Fit™ 3000 RPM Replacement Motor Kit With Fan Blades

The MARS 90971 Super-Fit™ replacement motor kit with fan blades is designed to provide all the material necessary to replace virtually any existing application that requires a 3/8", 1/2", or 5/8" stack motor.

The motor features a specially designed recirculating oil system for long life.

Each kit includes: MARS Super-Fit™ Motor, hardware plus a 4" diameter fan blade and a 5.5" diameter fan blade.



Features:

- Sleeve bearings
- All angle mount
- UL and CSA recognized
- Impedance protection
- Mechanically reversible
- Recirculating oil system

Specifications:

- Class "A" insulation
- 3000 RPM
- 60 Hz

3000 RPM – Mechanically Reversible

MARS NO.	HP	VOLTS	AMPS	SHAFT	STACK
90971	1/130	120	0.41	1.42" x 3/16"	5/8"

MARS 3.3" Commercial Refrigeration Multi-Horsepower Motors

These motors replace hundreds of OEM shaded pole evaporator fan motors found in Bohn, Nutone, Chandler, Larkin, Kramer, Climate Control, McQuay, Heatcraft and reduce truck stock costs.

These PSC type motors deliver more power and lower amp draw compared to shaded pole.

Features:

- Sleeve bearing, single speed
- Mounting - extended thru-bolt with nuts
- Low temp lubricant
- Capacitor included
- Open ventilation

Specifications:

- Class "B" insulation
- 60 Hz
- Thermal overload protected

Replaces 12 Motor Ratings:

- 1/12HP CW or CCW 115V or 230V
- 1/15HP CW or CCW 115V or 230V
- 1/20HP CW or CCW 115V or 230V

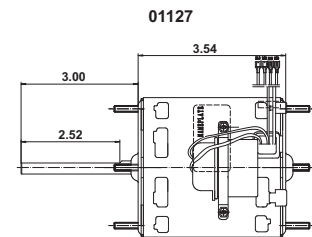
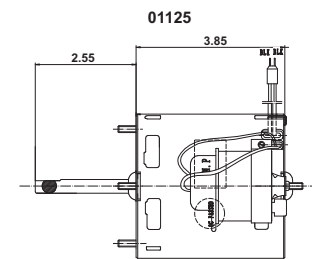

1550 RPM

MARS NO.	HP	VOLTS	ROT	AMPS	CAP INCLUDED	SHAFT LENGTH AND DIAMETER
01125	1/12, 1/15, 1/18	208-230	CW LE	0.56/0.50	4 MFD 370V	2.55 x 5/16
01127	1/12, 1/15, 1/20	115/230	REV	1.1/0.60	7.5 MFD 370V	3.00 x 5/16

Cross Reference:

MARS NO.	ACME MIAMI	GEM	UNI-LINE ROBERT SHAW	SUPCO
90971	600 700 710 AM-4670	EM670	33-670 (14001)	SM-670

Refrigeration Fan Motors / Draft Inducer Blowers

MARS Super-Fit™ 3.3" Commercial Refrigeration Evaporator Fan and Blower Motors

Application:

Can be used to replace virtually all popular 3.3" dia. commercial refrigeration evaporator fan motors.

Features:

- Adaptable to front or rear mount
- All angle operation
- Specially selected low temp. oil
- Full flatted black oxide shafts
- U.L. and C.S.A. recognized thermal protection

Specifications:

- Single phase, 60 Hertz
- Thermal overload protected
- 12 inch leads

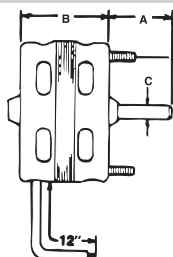

1550 RPM

MARS NO.	HP	VOLTS	AMPS	ROT OLE	DIMENSIONS			MOUNTING STUD LOCATION
					A	B	C	
09917	1/20	115	1.7	CW	2.50	2.96	5/16	SE
09927	1/20	208/230	0.96	CW	2.50	2.96	5/16	SE

MARS One-On-One™ 3.3" Commercial Refrigeration Evaporator Fan and Blower Motors

These motors feature original OEM-type plugs, wiring harness and conduit box (where appropriate).

Features:

- Sleeve bearing
- Original OEM-type mounting
- Original OEM-type wiring
- Specially selected low temp oil
- Full flatted black oxide shafts

Specifications:

- Single phase
- Thermal overload protected
- 12-1/2 inch leads



Bohn Applications/with Lyall Plug

MARS NO.	HP	RPM	VOLTS	AMPS	ROT OLE	DIMENSIONS			MOUNTING STUD LOCATION
						A	B	C	
09930	1/20	1550	115	1.7	CW	3	3	5/16	LE and SE
09931	1/15	1550	230	1.1	CW	3	3.5	5/16	SE

1550 RPM – Larkin Applications/with Lyall Plug

MARS NO.	HP	VOLTS	AMPS	ROT OLE	DIMENSIONS			MOUNTING STUD LOCATION
					A	B	C	
09932	1/20	115	1.7	CCW	2.25	2.75	5/16	LE
09933	1/20	208/230	1.0	CCW	2.25	3	5/16	LE

1550 RPM – McQuay Applications

MARS NO.	HP	VOLTS	AMPS	ROT OLE	DIMENSIONS			MOUNTING STUD LOCATION
					A	B	C	
09934	1/15	115/230	2.1/1.1	CW	2.5	3.5	5/16	SE

See diagram above for dimensions

Draft Inducer Blowers

Ball Bearing

MARS draft inducer blower assemblies are designed and manufactured to serve as drop-in, exact replacements.

Specifications:

- C-Frame
- Single Speed
- 60 Hz
- Thermal protected, air over
- Single phase

Draft Inducer Blowers

MARS NO.	OEM	OEM NO.	APPL.	HP	VOLTS	AMPS	RPM	CAP INCL.
10566	Carrier	HC27Q118	80+ Furnace	1/4	115	0.38	3030	5MFD/370
10704	Carrier	HC21ZE117	80+ Furnace	1/22	115	1.9	-	-
10709	Carrier	HC24HE230	80+ Furnace	1/40	208/230	1.0	-	-
10556	Nordyne	622567	80+ Furnace	1/33	115	0.43	3000	4MFD/250V
10558	Nordyne	622302	90+ Furnace	1/31	115	0.46	3300	6MFD/250V
10550	Goodman	0131G00007	80+ Furnace	1/50	230	0.24	3000	2MFD/370V
10551	Goodman	0131G00009	80+ Furnace	1/32	230	0.24	3000	2MFD/370V
10552	Goodman	0131M00121	80+ Furnace	1/50	230	0.22	3000	2MFD/370V
10553	Goodman	0131M00002P	80+ Furnace	1/50	115	0.40	3000	6MFD/250V
10555	Goodman	0271F00126	90+ Furnace	1/32	115	0.46	3150/2950	6MFD/250V
10563	Trane	D965130P01	80+ Furnace	1/39	230	0.22	2800/1500	2MFD/370V
10564	Trane	D965129P01	80+ Furnace	1/39	230	0.22	2800/1500	2MFD/370V
10565	Trane	D965128P01	80+ Furnace	1/34	230	0.24	3000	2MFD/370V

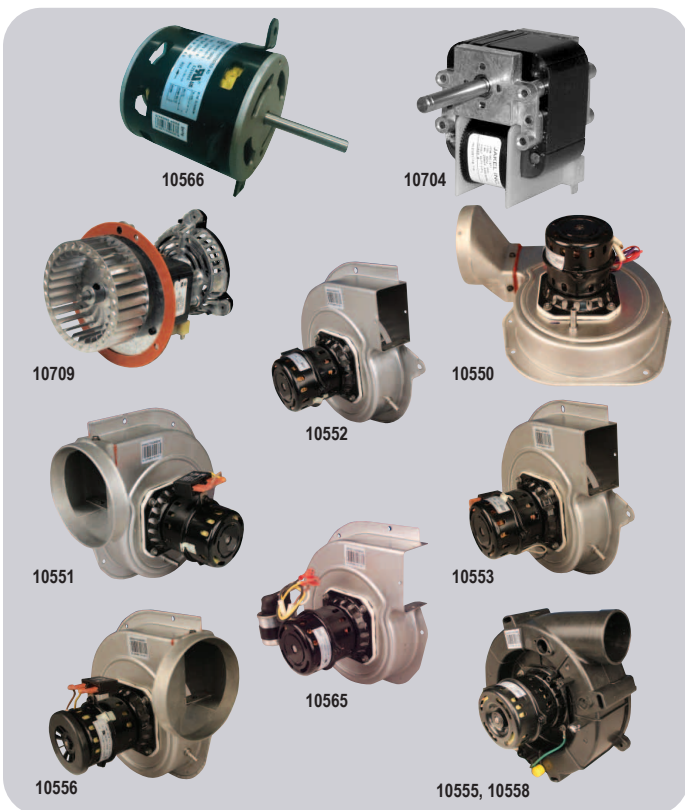

One-On-One™ Direct Replacement Motors

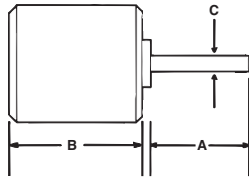

Replaces: Carrier HC33GE233

MARS USA, 5-1/2 inch diam., totally enclosed, ball bearing, capacitor required, 5 MFD @ 370V (MARS No. 12005, 12905, 14005), CW OSE

MARS NO.	HP	VOLTS	RPM/SPEEDS	ROT OSE	AMPS	DIMENSIONS		
						A	B	C
10234	1/10	208/230	1100/1	CW	0.77	1.8	3.8	1/2

Replaces: Goodman 0131M00019P

MARS USA, 5-1/2 inch diam., totally enclosed, ball bearing, capacitor required, 5 MFD @ 370V (MARS No. 12005, 12905, 14005), CCW OSE

MARS NO.	HP	VOLTS	RPM/SPEEDS	ROT OSE	AMPS	DIMENSIONS		
						A	B	C
10230	1/4	208/230	1100/1	CCW	1.26	3	4.1	1/2

Replaces: Goodman 0131M00060

MARS USA, 5-1/2 inch diam., totally enclosed, ball bearing, capacitor required, 5 MFD @ 370V (MARS No. 12005, 12905, 14005), CCW OSE

MARS NO.	HP	VOLTS	RPM/SPEEDS	ROT OSE	AMPS	DIMENSIONS		
						A	B	C
10232	1/6	208/230	810/1	CCW	1.1	3	4.1	1/2

Replaces: Goodman G3911

MARS USA, 5 1/2 inch diam. Totally enclosed, ball bearing, capacitor required, 5 MFD @ 370V (MARS No. 12005, 12905, 14005), CCW OSE

MARS NO.	HP	VOLTS	RPM/SPEEDS	ROT OSE	AMPS	DIMENSIONS		
						A	B	C
03242	1/6	208/230	1075/1	CCW	1.0	1	2.75	1/2

Replaces: Goodman 0131M00294

MARS USA, 5-1/2 inch diam., totally enclosed, ball bearing, capacitor required, 5 MFD @ 370V (MARS No. 12005, 12905, 14005), CCW OSE

MARS NO.	HP	VOLTS	RPM/SPEEDS	ROT OSE	AMPS	DIMENSIONS		
						A	B	C
10233	1/8	208/230	1050/1	CCW	0.70	2.5	4.1	1/2

Replaces: Goodman 0131F00022

MARS USA, 5-1/2 inch diam., totally enclosed, ball bearing, capacitor required, 20 MFD @ 370V (MARS No. 12014, 12914, 14014), CW OSE

MARS NO.	HP	VOLTS	RPM/SPEEDS	ROT OSE	AMPS	DIMENSIONS		
						A	B	C
10594	1/2	115	1130/4	CW	8.1	4	5.1	1/2

Replaces: For use with Coleman and Evcon Equipment

5-1/2 inch diam., totally enclosed, ball bearing, capacitor required, 5 MFD @ 440V (MARS No. 12029, 12929, 14029), CCW OSE

MARS NO.	HP	VOLTS/PHASE	RPM/SPEEDS	ROT OSE	AMPS	DIMENSIONS		
						A	B	C
10570	1/3	575/1	850/1	CCW	0.66	2.5	6.6	1/2

Replaces: For use with Coleman and Evcon Equipment

5-1/2 inch diam., totally enclosed, ball bearing, capacitor required, 10 MFD @ 440V (MARS No. 12032, 12932, 14032), CCW OSE

MARS NO.	HP	VOLTS/PHASE	RPM/SPEEDS	ROT OSE	AMPS	DIMENSIONS		
						A	B	C
10571	3/4	575/1	1100/1	CW-LE	1.35	3.5	5.7	1/2

OEM Direct Replacement Motors For Copeland

Specifications:

- Class "B" insulation
- 50/60 Hz
- Single phase
- Single speed
- Thermal overload protected
- Continuous air over

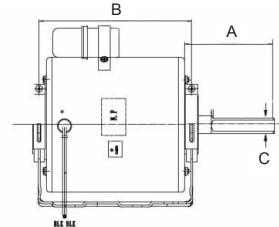

MARS NO.	HP	VOLTS	ROT OSE	AMPS	RPM	CAP INCLUDED	ENCL.	DIMENSIONS		
								A	B	C
10227	1/3	230	CW	2.2	1625	4MFD/370V	TEAO	1.75	5.87	1/2
10228	1/6	208-230	CW	1.1	1550	3MFD/370V	OAO	3.07	3.69	1/2
10229	1/4	208-230	CW	1.5	1625	5MFD/370V	OAO	3.07	4.32	1/2
10264	1/4	230	CW	2.1	1550	5MFD/370V	ODP	3.00	4.20	1/2
10265	1/6	208-230	Rev	1.1	1550	3MFD/370V	OAO	3.00	3.73	1/2

Tech Tip

Always replace the capacitor when replacing a PSC motor.

Mounting Brackets

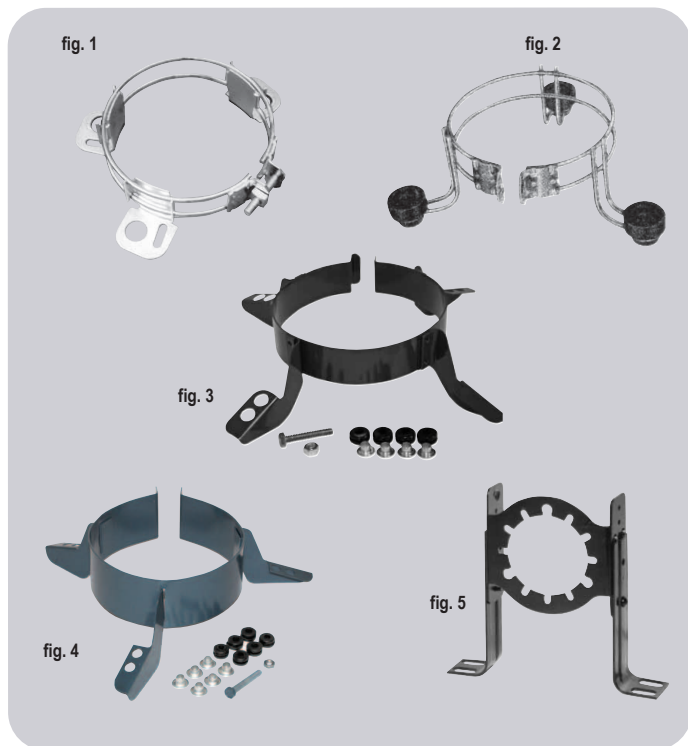

MARS NO.	USED ON	DESCRIPTION	FIG. NO.
08020	39 frame and 5-1/2 in. diam. motors	adj. lug mounting bracket fits triangular bolt patterns of 6-1/8 in. to 6-9/16 in. bolt to bolt (1/4 in. x 7/8 in. and 3/4 in. x 1-3/8 in. knockouts)	1
08021	5-1/2 in. fixed motor mtg. bracket with grommets	for mounting blower motor with large wheel opening fits any 5-1/2 in. diameter motor	2
08024	5 in. fixed motor mtg. bracket with grommets	for mounting blower motor with large wheel opening fits any 5 in. diameter motor	2
08049	29 and 39 frame motors, 5 in. motors	3 Wing Torsion-Flex mounting adapter kit for 9 in. and 10 in. blowers	4
08050	48 frame, 5-5/8 in. and 5-1/2 in. diam. motors	3 Wing Torsion-Flex mounting adapter kit for 9 in. and 10 in. blowers	4
08047	48 frame, 5-5/8 in. and 5-1/2 in. diam. motors	4 Wing Torsion-Flex mounting adapter kit for 9 in. and 10 in. blowers	3
08004	51 frame motors	shaft height adjustable 4-1/8 in. to 5-3/8 in.	5

Premium Belly Bands

Applications:

Residential HVAC,
Direct Drive Blowers

- Welded 3-ring bracket
- Anodized steel rod construction
- Includes 3 sets of rubber grommets, 3 sheet metal screws, 3 galvanized steel sleeves, 1 bolt, 1 nut



MARS NO.	DESCRIPTION
08025	10" Bolt Pattern
08026	11" Bolt Pattern

Applications:

Residential HVAC,
Direct Drive Blowers

- Welded 4-ring bracket
- Anodized steel rod construction
- Includes 4 sets of rubber grommets, 4 sheet metal screws, 4 galvanized steel sleeves, 1 bolt, 1 nut



MARS NO.	DESCRIPTION
08027	13" Bolt Pattern

Rheem Adapter Belly Bands

Applications:

Rheem Blower Assemblies

This kit allows the use of standard 5.5" blower motors (without Rheem mounting holes) in Rheem original equipment blower applications.

- Welded 4-ring bracket
- Anodized steel rod construction
- Includes bracket, blower housing tabs, hardware & grommets



MARS NO.	DESCRIPTION
08028	Rheem Adapter

MARS No.	Description	Century / AO Smith	US Motors/ Emerson	Fasco	GE/ Genteq	Marathon	Packard	Nordyne/ Partners Choice	Rheem/Ruud Protech	Carrier/ Totaline RCD	Wagner	York Source 1	ROTOM
Condenser Fan													
10725	1/8 HP, 208-230 V, 1075 RPM, B/B	-	-	D919	-	-	-	-	-	-	-	-	-
10727	1/6 HP, 208-230 V, 1075 RPM, B/B	FSE1016	1859	D917	3727	X411	43727	01-0160	W51-16CJA1-01	P257-8727	WG840727	S1-FHM3727	-
10728	1/4 HP, 208-230 V, 1075 RPM, B/B	FSE1026	1860	D909	3728	X412	43728	01-0161	W51-14CJA1-01	P257-8728	WG840728	S1-FHM3728	-
10729	1/3 HP, 208-230 V, 1075 RPM, B/B	FSE1036	1861	D908	3729	X413	43729	01-0162	W51-13CJA1-01	P257-8729	WG840729	S1-FHM3729	-
10730	1/2 HP, 208-230 V, 1075 RPM, B/B	FSE1056	1862	D907	3730	X414	43730	01-0163	W51-12CJA1-01	P257-8730	WG840730	S1-FHM3730	-
10731	3/4 HP, 208-230 V, 1075 RPM, B/B	FSE1076	1868	D933	3731	-	43731	01-0164	51-42534-19	P257-8731	WG840731	S1-FHM3731	-
10403	1/6 HP, 208-230 V, 825 RPM, B/B	FSE1018SF	1873	D798	3403	X465	60825	0165	51-23055-12	-	-	-	-
10404	1/4 HP, 208-230 V, 825 RPM, B/B	FSE1028SF	1874	D934	3404	-	40825	0166	51-23054-13	-	WG840204	S1-FHM3204	R22445
10405	1/3 HP, 208-230 V, 825 RPM, B/B	FSE1038SF	1875	D796	3405	X451	30825	0167	-	P257-8026	WG840205	S1-FHM3205	R22345
10746	1/2 HP, 208-230 V, 825 RPM, B/B	FSE1058SF	1870	D713	3746	X452	-	0168	-	-	-	-	R22245
10203	1/6 HP, 208-230 V, 825 RPM, B/B	FE1018SF, FSE1018SF	-	D793	3203	X465	3203	-	-	-	-	-	CF-816
10204	1/4 HP, 208-230 V, 825 RPM, B/B	FE1028SF, FSE1028SF	1874	-	3204	X450	40825	-	-	-	-	S1-FHM3204	CF-814
10205	1/3 HP, 208-230 V, 825 RPM, B/B	FE1038SF, FSE1038SF	1875	-	3205	X451	30825	-	-	-	-	S1-FHM3205	-
10747	1/2 HP, 208-230 V, 825 RPM	F1058	-	-	3736	X452	-	-	-	-	-	-	-
10732	1/6 HP, 208-230 V, 1075 RPM, B/B	FE1016SF	2246	-	3726	X427	-	-	-	-	-	-	CF-3726
10733	1/4 HP, 208-230 V, 1075 RPM, B/B	F1026S, FE1026SF, FSE1026SV1	1876	D7909	3732	X428	43732	-	-	-	-	-	CF-3732
10734	1/3 HP, 208-230 V, 1075 RPM, B/B	F1036S, FE1036S	1877	D7908	3733	X413	43733	-	-	-	-	-	CF-3733
10735	1/2 HP, 208-230 V, 1075 RPM, B/B	F1056S, FE1056SF	1878	D7907	3734	X414	43734	-	-	-	-	-	CF-3734
10736	3/4 HP, 208-230 V, 1075 RPM, B/B	F1076SF, FS1076S	1879	-	3735	-	43735	-	-	-	-	-	CF-3735
10327	1/6 HP, 208-230 V, 1075 RPM	-	8661	D718	3327	-	-	-	W51-16CJA1-01	-	-	-	-
10328	1/4 HP, 208-230 V, 1075 RPM	FS1026S	3851	D823	3328	-	-	-	W51-14CJA1-01	-	-	-	-
10329	1/3 HP, 208-230 V, 1075 RPM	FS1036S	6880	D748/D749	3329	-	-	-	W51-13CJA1-01	-	-	-	-
10330	1/2 HP, 208-230 V, 1075 RPM, B/B	FS1056S	3852	D745/D804	3330	-	-	-	W51-12CJA1-01	-	-	-	-
10331	3/4 HP, 208-230 V, 1075 RPM	FS1076S	3097	D929	3331	-	-	-	-	-	-	-	-
23728	1/4HP 208-230V 1075RPM 3W	FSE1026S	1860	D909	3728	X412	43728	01-0161	W51-14CJA1-01	P257-8728	WG840729	S1-FHM3728	-
23729	1/3HP 208-230V 1075RPM 3W	FSE1036S	1861	D908	3729	X413	43729	01-0162	W51-13CJA1-01	P257-8729	WG840729	S1-FHM3729	-
Multi-Horsepower Condenser Fan													
10458	1/6, 1/5, 1/4, 1/3, 1075 RPM, 208-230 V, WIZ, B/B	ORM5458	5458	-	3458	-	-	-	W51-MHCJA1-01	-	-	-	R22402
10459	1/8, 1/6, 1/5, 1/4, 1/3, 825RPM, 208-230 V, WIZ, B/B	ORM5488B	5464	-	3459	-	-	-	-	-	-	-	-
10465	1/6, 1/5, 1/4, 1/3, 1075 RPM, 208-230 V, B/B	FE6000	5462	D2827	3465	X072	-	01-0695	51-23053-21	P257-E5462	WG840465	S1-FHM3465	R22605
10468	1/5, 1/4, 1/3, 1/2, 1075 RPM, 208-230 V, B/B	FE6002	5465	-	3468	X076	-	01-0697	-	P257-E5465	WG840468	S1-FHM3468	R22602
10469	1/6, 1/5, 1/4, 1/3, 825 RPM, 208-230 V, B/B	FE6001	5464	D2826	3469	-	-	01-0696	51-20760-11	P257-E5464	WG840469	S1-FHM3469	R22601
Direct Drive													
10583	1/4 HP, 115 V, 1075 RPM	DL1026	1863	D721	3583	X000	43583	01-0169	W51-14BAA3-01	P257-8583	WG840583	S1-FHM3583	DD-3583
10584	1/4 HP, 208-230 V, 1075 RPM	D1026	1971	D725	3584	X001	43584	01-0173	W51-14BJA3-01	P257-8584	WG840584	S1-FHM3584	DD-3584
10585	1/3 HP, 115 V, 1075 RPM	DL1036	1864	D727	3585	X002	43585	01-0170	W51-13BAA3-01	P257-8585	WG840585	S1-FHM3585	DD-3585
10586	1/3 HP, 208-230 V, 1075 RPM	D1036	1972	D923	3586	X003	43586	01-0174	W51-13BJA3-01	P257-8586	WG840586	S1-FHM3586	DD-3586
10587	1/2 HP, 115 V, 1075 RPM	DL1056	1865	D701	3587	X004	43587	01-0171	W51-12BAA3-01	P257-8587	WG840587	S1-FHM3587	DD-3587
10588	1/2 HP, 208-230 V, 1075 RPM	D1056	1973	D703	3588	X005	43588	01-0175	W51-12BJA3-01	P257-8588	WG840588	S1-FHM3588	DD-3588
10589	3/4 HP, 115 V, 1075 RPM	DL1076	8904	D728	3589	X009	43589	01-0172	W51-34BAA3-01	P257-8589	WG840589	S1-FHM3589	DD-3589
10590	3/4 HP, 208-230 V, 1075 RPM	D1076	8905	D729	3590	X010	43590	01-0176	W51-34BJA3-01	P257-8590	WG840590	S1-FHM3590	DD-3590
10591	1 HP, 115 V, 1075 RPM	BDL1106	8906	D712	3595	-	-	-	-	-	WG840595	S1-FHM3595	R6-R42812
10592	1 HP, 208-230 V, 1075 RPM	BD1106	8907	D711	3596	X023	48907	-	-	-	WG840596	S1-FHM3596	R6-R42842
10683	1/4 HP, 115 V, 1075 RPM	FML1026	3783	D1730	3783	-	-	-	-	-	-	-	-
10684	1/4 HP, 208-230 V, 1075 RPM	FM1026	3784	D1733	3784	-	-	-	-	-	-	-	-
10685	1/3 HP, 115 V, 1075 RPM	FML1036	3785	D1731	3785	-	-	-	-	-	-	-	-
10686	1/3 HP, 208-230 V, 1075 RPM	FM1036	3786	D1734	3786	-	-	-	-	-	-	-	-
10687	1/2 HP, 115 V, 1075 RPM	FML1056	3787	D1732	3787	-	-	-	-	-	-	-	-
10688	1/2 HP, 208-230 V, 1075 RPM	FM1056	3788	D1735	3788	-	-	-	-	-	-	-	-
10689	3/4 HP, 115 V, 1075 RPM	FML1076V1	-	-	3789	-	-	-	-	-	-	-	-
10690	3/4 HP, 208-230 V, 1075 RPM	FM1076	-	-	3790	-	-	-	-	-	-	-	-

Disclaimer: Every effort has been made to insure the accuracy of motor data and cross reference information. Design changes may result in different operating characteristics or dimensional changes from one manufacturer to another. Therefore, MARS cannot accept responsibility for the ultimate selection. For additional information, please contact MARS.

Note: B/B – Ball Bearing
* 2 Speed Motor



Toll Free (800) 445-4155 • Fax (631) 348-7160
www.marsdelivers.com

WARNING:
Cancer and Reproductive Harm
www.P65Warnings.ca.gov

Cross Reference / MARS Motors

MARS No.	Description	Century / AO Smith	US Motors/ Emerson	Fasco	GE/ Genteq	Marathon	Packard	Nordyne/ Partners Choice	Rheem/Ruud Protech	Carrier/ Totaline RCD	Wagner	York Source 1	ROTHOM
Multi-Horsepower Direct Drive													
10463	1/6, 1/5, 1/4, 1/3, 1/2 HP, 115 V, 1075 RPM	FDL6001	5460	D2835	3463	X077	-	01-0698	51-23012-41	P257-E5460	WG840463	S1-FHM3463	R43600
10464	1/6, 1/5, 1/4, 1/3, 1/2 HP, 208-230 V, 1075 RPM	FD6000	5461	D833	3464	X073	-	01-0699	51-23022-41	P257-E5461	WG840464	S1-FHM3464	R43601
10466	1/5, 1/4, 1/3, 1/2, 3/4 HP, 115 V, 1075 RPM, B/B	FDL6002	5470	D2832	3466	X074	-	01-0701	51-23017-42	P257-E5470	WG840466	S1-FHM3466	R43602
10467	1/5, 1/4, 1/3, 1/2, 3/4 HP, 208-230 V, 1075 RPM, B/B	FD6001	5471	D2833	3467	X075	-	01-0702	51-23022-41	P257-E5471	WG840467	S1-FHM3467	R43603
10479	1/8, 1/4, 1/3 HP, 825 RPM, 208-230 V	-	5469	-	-	-	-	-	-	-	-	-	-
20538	1/2 HP, 460 V, 1075 RPM, B/B	-	-	-	-	X038	-	-	-	-	-	-	-
20580	1/4, 1/3 HP, 460 V, 1075 RPM, B/B	BDH1036*	-	-	3280	-	-	-	-	-	-	-	M2-R32712
20581	3/4, 1/2 HP, 460 V, 1075 RPM, B/B	BDH1076*	8947	-	3290	-	-	-	-	-	-	-	M2-R32426

MARS No.	Description	Century/ AO Smith	US Motors/ Emerson	Fasco	GE/Genteq	Rheem/Ruud Protech	Wagner	York Source 1	ROTHOM
Sunslinger Condenser Fan 70°C									
20727	1/6 HP Condenser Fan, 208-230 V, 1075 RPM, B/B	FE1016SF	1859H	-	3726HS	-	WG840727HT	-	-
20728	1/4 HP Condenser Fan, 208-230 V, 1075 RPM, B/B	FE1026SF	1860H	-	3732HS	-	WG840728HT	S1-FHM3728HT	-
20729	1/3 HP Condenser Fan, 208-230 V, 1075 RPM, B/B	FE1036SF	1861H	-	3733HS	-	WG840729HT	S1-FHM3729HT	-
20730	1/2 HP Condenser Fan, 208-230 V, 1075 RPM, B/B	FE1056SF	1862H	-	3734HS	-	WG840730HT	S1-FHM3730HT	-
20731	3/4 HP Condenser Fan, 208-230 V, 1075 RPM, B/B	FE1076SF	1868H	-	3735HS	-	WG840731HT	-	-
20402	1/8 HP Condenser Fan, 208-230 V, 825 RPM, B/B	FE1008SF	1872H	-	3202HS	-	-	-	-
20403	1/6 HP Condenser Fan, 208-230 V, 825 RPM, B/B	FE1018SF	1873H	-	3203HS	-	-	-	-
20404	1/4 HP Condenser Fan, 208-230 V, 825 RPM, B/B	FE1028SF	1874H	-	3204HS	-	WG840204HT	S1-FHM3204HT	-
20405	1/3 HP Condenser Fan, 208-230 V, 825 RPM, B/B	FE1038SF	1875H	-	3205HS	-	WG840405HT	S1-FHM3205HT	-
20746	1/2 HP Condenser Fan, 208-230 V, 825 RPM, B/B	FE1058SF	1870H	-	3747HS	-	-	-	-
20846	1/4 HP Condenser Fan, 460 V, 1075 RPM, B/B, Shaft Up	FEH1026S	3736H	D980	3736HS	51-19704-01	WG840736HT	S1-FHM3736HT	R31710
20847	1/3 HP Condenser Fan, 460 V, 1075 RPM, B/B, Shaft Up	FEH1036S	3737H	D982	3737HS	51-23063-11	WG840737HT	S1-FHM3737HT	R31712
20848	1/2 HP Condenser Fan, 460 V, 1075 RPM, B/B, Shaft Up	FEH1056S	3738H	D802	3738HS	51-20929-01	WG840738HT	S1-FHM3738HT	R31718
20849	3/4 HP Condenser Fan, 460 V, 1075 RPM, B/B, Shaft Up	FEH1076S	3739H	-	3739HS	-	WG840739HT	-	-
Sunslinger Multi-Horsepower Condenser Fan 70°C									
20458	1/6, 1/5, 1/4, 1/3 Multi-HP, Condenser Fan, 1075 RPM, 208-230 V, B/B	ORM5458F	3323H	-	3458HS	-	-	-	-
20459	1/8, 1/6, 1/5, 1/4, 1/3 Multi-HP, Condenser Fan, 825RPM, 208-230 V, B/B	ORM5488F	1874H	-	3459HS	-	-	-	-
20465	1/6, 1/5, 1/4, 1/3 Multi-HP, Condenser Fan, 1075 RPM, 208-230 V, B/B	FE6000F	5462H	-	3465HS	-	-	S1-FHM3465HT	-
20468	1/5, 1/4, 1/3, 1/2 Multi-HP, Condenser Fan, 1075 RPM, 208-230 V, B/B	FE6002F	5465H	-	3468HS	-	-	-	-
20469	1/6, 1/5, 1/4, 1/3 Multi-HP, Condenser Fan, 825 RPM, 208-230 V, B/B	FE6002F	5464H	-	3469HS	-	-	S1-FHM3469HT	-
Sunslinger 460V Condenser Fan 70°C									
20859	1/6 HP Condenser Fan, 460 V, 825 RPM, B/B	-	-	-	-	51-101774-06	-	-	R31716
20880	1/4 HP Condenser Fan, 460 V, 825 RPM, B/B	FEH1028S	1880	-	-	51-23064-12	-	-	R22275
20881	1/3 HP Condenser Fan, 460 V, 825 RPM, B/B	-	1881	D960	-	51-100998-26	-	-	R32714
20882	1/2 HP Condenser Fan, 460 V, 825 RPM, B/B	-	1882	D961	-	-	-	-	-
20835	1/6 HP Condenser Fan, 460 V, 1075 RPM, B/B	-	-	-	-	-	-	-	-
20836	1/4 HP Condenser Fan, 460 V, 1075 RPM, B/B	788A, FEH1026SF	3736H	D980	3736	51-19704-01	WG840736HT	S1-FHM3736HT	R31710
20837	1/3 HP Condenser Fan, 460 V, 1075 RPM, B/B	789A, FEH1036SF	3737H	D982	3737	51-23063-11	WG840737HT	S1-FHM3737HT	R31712
20838	1/2 HP Condenser Fan, 460 V, 1075 RPM, B/B	790A, FEH1056SF	3738H	D802	3738	51-20929-01	WG840738HT	S1-FHM3738HT	R31718
20842	3/4 HP Condenser Fan, 460 V, 1075 RPM, B/B	FEH1076SF	3742H	-	3739	-	WG840739HT	-	-
Sunslinger 460V Multi-Horsepower Condenser Fan 70°C									
20478	1/5, 1/4, 1/3, 1/2 Multi-HP, Condenser Fan, 1075 RPM, 460 V, B/B	ORM4658BF	-	-	-	-	-	-	-
20479	1/6, 1/5, 1/4, 1/3, Multi-HP, Condenser Fan, 1075 RPM, 460 V, B/B	ORM4659BF	-	-	-	-	-	-	-
20480	1/6, 1/5, 1/4, 1/3, 1/2 Multi-HP, Condenser Fan, 1075 RPM, 460 V, B/B	-	5480H	-	-	-	-	-	-
20481	3/4, 1/2, 1/3, 1/4 Multi-HP, Condenser Fan, 1075 RPM, 460 V, B/B	-	5481H	-	-	-	-	-	-
Sunslinger MAX Condenser Fan 80°C									
20791	3/4 HP Condenser Fan, 208-230 V, 1075 RPM, B/B	FE1076SU	-	-	-	-	-	-	-
20796	3/4 HP Condenser Fan, 208-230 V, 825 RPM, B/B	-	-	-	-	-	-	-	-

Disclaimer: Every effort has been made to insure the accuracy of motor data and cross reference information. Design changes may result in different operating characteristics or dimensional changes from one manufacturer to another. Therefore, MARS cannot accept responsibility for the ultimate selection. For additional information, please contact MARS.

Note: B/B – Ball Bearing



MARS No.	Description	Century/ AO Smith	US Motors/ Emerson	Fasco	Genteq	Magnetek	Marathon	Packard	Rheem/Ruud	ROTOM	Wagner
High Efficiency Direct Drive Motors											
10573	1/4 HP Direct Drive, 115V, 1075 RPM	DL1026, FDL1026	5460, 1863	D721, D2836	3983, 3583	0533	X000	43583, 63983	51-17947-11, 51-23012-41, 51-23014-32	R43600	WG840463, WG840583
10574	1/4 HP Direct Drive, 208-230V, 1075 RPM	D1026, FD1026	5461, 1971	D725	3984, 3584	0530	X001	43884, 63984	51-23022-41, 51-23024-31	DD3584, R43584	WG840584
10575	1/3 HP Direct Drive, 115V, 1075 RPM	DL1036, FDL1036	5460, 1864	D727	3985, 3585	0532	X002	43585, 63985	-	-	-
10576	1/3 HP Direct Drive, 208-230V, 1075 RPM	D1036, FD1036	5461, 1972	D923	3986, 3586	0529	X003	43586, 63986	-	-	-
10577	1/2 HP Direct Drive, 115V, 1075 RPM	DL1056, FDL1056	5460, 1865	D701	3987, 3587	0531	X004	43587, 63987	-	-	-
10578	1/2 HP Direct Drive, 208-230V, 1075 RPM	D1056, FD1056, F1076SV1	5461, 1973	D703	3988, 3588	0528	X005	43588, 63988	-	-	-
10579	3/4 HP Direct Drive, 115V, 1075 RPM	DL1076, FDL1076	5470, 8904	D728	3989, 3589	0678	X009	43589, 63989	-	-	-
10580	3/4 HP Direct Drive, 208-230V, 1075 RPM	D1076, FD1076	5471, 8905	D729	3990, 3590	0679	X010	43590, 63990	-	-	-

MARS No.	Description	Century/ AO Smith	Baldor	US Motors/ Emerson	Leeson	Marathon
Commercial Condenser Fan - Three Phase - Rigid Base						
10513	1HP 1140 RPM 208-230/460 CF	H1050A	-	1820H	-	X513
10523	1-1/2 HP 1140 RPM 208-230/460V	H1051A	CFM3166A	1821H	111148	X523
10531	1-1/2 HP 850 RPM 208-230/460 CF	H1054A	-	1831H	-	X531
10533	1/2 HP 1140 RPM 208-230/460 CF	-	-	-	-	X533

MARS No.	Description	Century/ AO Smith	Baldor	US Motors/ Emerson	Fasco	KeepRite	Magnetek	Marathon
Commercial Condenser Fan - Three Phase - Belly Band								
10502	1 HP 1140 RPM 208-230/460 CF	FC3106F	CFM3156A	1818H	-	-	H667	X502
10503	1-1/2 HP 1140 RPM 208-230/460	H1051A	CFM3166A	1819H	D6610	-	H767	X503
10507	1 HP 850 RPM 208-230/460 CF	H1053A	-	1828H	-	-	H686	X507
10509	2 HP 1140 RPM 208-230/460 CF	H698	-	-	-	-	-	X509
10530	1-1/2 HP 85 0RPM 208-230/460 CF	H1054A	-	1832H	-	-	-	X530

MARS No.	Description	Century/ AO Smith	Baldor	US Motors/ Emerson	Genteq	Magnetek	Marathon
1 Phase Heating - Split Phase Fan & Blower							
10302	1/4 HP 1725RPM 115V FAN & BLWR	919L	-	DB14B2N49	-	919	B302
10303	1/4 HP 1725RPM 115V FAN & BLWR	920L, GF2024	RSP1441A	8000, 3618	4701, 4730	808	B303, B206
10304	1/3 HP 1725RPM 115V FAN & BLWR	921L, RB2034L	-	D13B2N4Z9	-	921	B304
10305	1/3 HP 1725RPM 115V FAN & BLWR	922L, RB2034	-	8100	-	922	B305, B207
10306	1/2 HP 1725RPM 115V FAN & BLWR	-	-	D12C2J49	-	-	B306
10307	1/2 HP 1725RPM 115V FAN & BLWR	GF2054	RSP3451A	8200, PD6006	4708, 4733	-	B307

MARS No.	Description	Century/ AO Smith	Baldor	US Motors/ Emerson	Fasco	Leeson	Magnetek	Marathon
1 Phase Heating - Cap Start Fan & Blower								
10313	1/4 HP 1725 RPM 115/208-230V	C196L	RL1203A	D14CA2P4Z9	-	100109.00	C196	B313
10315	1/3 HP 172 5RPM 115/208-230V	RBF1034A	-	D13CA3J9	-	-	-	B315
10317	1/2 HP 1725 RPM 115/208-230V	BK1054, C412V1	-	D12CA2J9	D6084	100011.00	-	B317
10319	3/4 HP 1725 RPM 115/208-230V	C426V1, RB1074A	RL1307A	D34CA2JH9	-	100012.00	-	B319
10321	1 HP 1725 RPM 115/208-230V	C523V1	RL1310A	D1CA2JH9	D6088	110007.00	-	4688

Disclaimer: Every effort has been made to insure the accuracy of motor data and cross reference information. Design changes may result in different operating characteristics or dimensional changes from one manufacturer to another. Therefore, MARS cannot accept responsibility for the ultimate selection. For additional information, please contact MARS.

Note: B/B – Ball Bearing
* 2 Speed Motor



Toll Free (800) 445-4155 • Fax (631) 348-7160
www.marsdelivers.com

WARNING:
Cancer and Reproductive Harm
www.P65Warnings.ca.gov

Cross Reference / MARS Motors

MARS No.	Description	Century/ AO Smith	US Motors/ Emerson	Marathon
Oil Burner Motors				
30004	1/4 HP 115V 3450 RPM	EL2022	2302	O004
30011	1/2 HP 115/230 3450 RPM	-	3267	O011
30100	1/7 HP 115V 3450 RPM	EL2002	3083	O100
30600	1/8 HP 115V 1725 RPM	EL2005	3196	O600
30601	1/6 HP 115V 1725 RPM	XEL2014	3252	O601
30701	1/7 HP 115V 3450 RPM	-	3247	O701

MARS No.	Description	Century/ AO Smith	US Motors/ Emerson	Marathon
Unit Heater - PSC, TEAO				
30301	1/6 HP 1075RPM 115 UNIT HTR	UH1016, US1016	1386	X302
30303	1/4 HP 1075RPM 115 UNIT HTR	566A, UH1026	1384	X303
30305	1/3 HP 1075RPM 115 UNIT HTR	UH1036	1388	X304

MARS No.	Description	Replaces	Azure®	Century/ AO Smith	US Motors/ Emerson	GE/Genteq
Azure® ECM Direct Drive						
10860	1/5-1/2 HP, Direct Drive ECM, 115/230 V, 1075 RPM, B/B	X13, PSC	10800	Comfort Select: CS1056, CSL1056	Rescue Ecotech: 5522ET, 5532ET, 5542ET (1/3HP & 1/2HP), 5552ET (1/2HP), 6631RS (1/2-1/3HP), 6630RS (1/2-1/3HP)	6001, 6002, 6005, 6103E, 6203E, 6105E, 6205E
10861	1/2-1 HP, Direct Drive ECM, 115/230 V, 1075 RPM, B/B	X13, PSC	10801	Comfort Select: CS1106, CSL1106	Rescue Ecotech: 5552ET, 5542ET (3/4HP), 6651RS (1HP), 6641RS (3/4HP), 6650RS (1HP), 6640RS (3/4HP)	6003, 6004, 6010, 6107E, 6207E, 6110E, 6210E
10867	1/8-1/3 HP, Direct Drive ECM, 115/230/277 V, 1075 RPM, B/B	5" PSC Direct Drive	-	-	-	-
10865	AZURE 1/3 - 1/2 HP ECM D/D	PSC	-	-	Rescue Ecotech 5522ET, 5532ET	Evergreen 6005
10866	AZURE 3/4 - 1 HP ECM D/D	PSC	-	-	Rescue Ecotech 5542ET, 5552ET	Evergreen 6010
10858	1/5-1/2 HP AZURE FOR X13	X13, Ensite, Endura	-	-	Rescue EZ13 5632, Rescue Select Pro 6633	Evergreen 6103E, 6203E, 6105E, 6205E
10859	1/2-1 HP AZURE FOR X13	X13, Ensite, Endura	-	-	Rescue EZ13 5642, EZ13 5652, Rescue Select Pro 6643, 6653	Evergreen 6107E, 6207E, 6110E, 6210E
10857	Azure VS 1/2 to 1 HP D/D	Variable Speed	-	-	Rescue EZ16 5860, EZ16 5861	Evergreen 6507V, 6510V, Interface Board 56010

MARS No.	Description	Replaces
Azure® ECM Condenser Fan		
10874	1/8 - 1/3 HP, Condenser Fan ECM, 208-230 V, 825/1075 RPM, B/B	PSC motors 1/8 to 1/3 HP
10875	1/8 - 1/3 HP, Condenser Fan ECM, 208-230 V, 1075 RPM, B/B	PSC motors 1/8 to 1/3 HP
10872	1/3 - 1/2 HP, Condenser Fan ECM, 208-230 V, 1075 RPM, B/B	PSC motors 1/3 to 1/2 HP

MARS No.	Description	Replaces	Bohn	Regal Beloit/Morrill	Wellington	US Motors
Azure® ECM 3.3" Commercial Refrigeration						
10850	1/15-1/25 HP, 3.3" Commercial Refrigeration ECM, 115/230 V, 1550/800 RPM, B/B	-	-	5100, 5105, 5106, 5101, 5111, 5200, 5201, 5205, 5206, 5211	ECR 85/95	EC5404D, EC5405D
10852	1/15-1/25 HP, 3.3" Commercial Refrigeration ECM, 115/230 V, 1550 RPM, B/B	Standard 3.3" motors	5008S, 5008T	5100, 5101, 5102, 5105, 5106, 5111, 5200, 5201, 5205, 5206, 5211	-	EC5404D, EC5405D

MARS No.	Description	Replaces	MARS	Century Motor	Hussmann	Morrill	US Motors Rescue
Azure® Commercial Refrigeration Watt (Reach-In) Motor							
10891	4-25 Watts, Commercial Refrigeration ECM, 115/230 V, 1550 RPM, B/B	All standard watt motors: 4 -25 W	10890	9207F2, 9208F2, 9211, 9212, 9213	4410547	5R999	EC5411D, EC5412D

Disclaimer: Every effort has been made to insure the accuracy of motor data and cross reference information. Design changes may result in different operating characteristics or dimensional changes from one manufacturer to another. Therefore, MARS cannot accept responsibility for the ultimate selection. For additional information, please contact MARS.

Note: B/B – Ball Bearing



MARS No.	Description	Century/ AO Smith	US Motors/ Emerson	GE/Genteq	Magnetek	Marathon	Packard	ROTOM
Belted Fan & Blower								
10401	1/4 HP, Belted Fan & Blower, 115 V, 1725 RPM	GF2024, RB2024	2889, 8000	4701	808, 802	B303, B206	45014	BF-4701
10406	1/3 HP, Belted Fan & Blower, 115 V, 1725 RPM	GF2034, RB2034	2888, 8100	4706	922, 805	B305, B207	45013	BF-4706
10408	1/2 HP, Belted Fan & Blower, 115 V, 1725 RPM	GF2054, BF2054	2887, 8200	4708	F681, 811	B208	45012	BF-4708

MARS No.	Description	Century/ AO Smith	US Motors/ Emerson	Fasco	GE/Genteq	Magnetek
21/29 Frame Replacement Commercial Refrigeration						
10611	1/20 HP, Commercial, 115/230 V, 1550 RPM	-	F1468	D484, D485	2331, 2332, 2341, 2342	610, 611
10615	1/10 HP, Commercial, 115/230 V, 1550 RPM	329P118, 326P119, RF4400, RF4401	F1469, F1470	D480, D481, D482, D483	2131, 2132, 2141, 2142, 2231, 2232, 2241, 2242	614, 615, 612, 613

MARS No.	Description	Century/ AO Smith	US Motors/ Emerson	Fasco	GE/Genteq	Heil Quaker	York Source 1
Super-Fit™ Multi-Horsepower Condenser Fan							
10722	1/8, 1/10, 1/12 HP, Multi-HP, Condenser Fan, 208-230 V, 1075 RPM, B/B	9722	5440*	-	5KCP29DCA323S, 5KCP29ECA328S, 5KCP29DCA329S, 5KCP29FCA322S,02243, 02248, 02249, 02251	-	17416, 17465, 17483, 17484
10723	1/4, 1/5, 1/6 HP, Multi-HP, Condenser Fan, 208-230 V, 1075 RPM, B/B	9723	5441*, 1901	D1071	5KCP29JCA324S, 5KCP29JCA325S, 5KCP29HCA326S, 5KCP29JCA327S, 5KCP29ECA321S, 02244, 02245, 02246, 02247, 02250	HQ1052662EM	-
10724	1/4, 1/5, 1/6 HP, Multi-HP, Condenser Fan, 208-230 V, 1675 RPM, B/B	9724	-	-	-	-	-

*70°C Heat Shield

MARS No.	Description	Century/ AO Smith	US Motors/ Emerson	Fasco	GE/Genteq	Packard
3.3" Multi-Horsepower Commercial Refrigeration						
01125	1/12, 1/15, 1/18 HP, Evap Fan Motor, 208-230 V, 1550 RPM	9720A	9656, 8658, 9664	7190-0442, D1125	-	41125
01127	1/12, 1/15, 1/20 HP, Evap Fan Motor, 115/230 V, 1550 RPM	9721	9650, 9651, 9652, 9653, 9656, 9662, 9664	D1101, D1103, D1122, D1123, D1124, D1125, D1126, D1127, D1152, D1154, PD1125, PD1127, 7163-2113, 7163-3371 7190-0442, 7190-2084, 7190-2255, 7190-2285, 7190-2969	5KSM59ES2001 5KSM59JSK143S 5KSM59JS5036S 5KSM59LS2262AS	49101

MARS No.	Description	Century/ AO Smith	US Motors/ Emerson	Fasco	Magnetek	Packard	RMR
3.3" Commercial Refrigeration							
09916	1/30 HP, Evap Fan Motor, 115 V 1550 RPM	AO126, AO127	-	D532, D181	28, 29	-	RR-1106
09917	1/20 HP, Evap Fan Motor, 115 V 1550 RPM	AO132, AO133	-	D132	572, 574, 30, 31	40132	RR-1107
09927	1/20 HP, Evap Fan Motor, 208-230 V 1550 RPM	AO188, AO189	-	D188, D189	575	40188	RR-4107
09938	1/30 HP, Evap Fan Motor, 115 V 1550 RPM	-	9656	D1125	-	-	-

MARS No.	Description	Century/ AO Smith	Fasco	GE	Magnetek/UE
Fan Coil Replacement Motor					
10889	1/10 HP, 115 V 1050 RPM	DBL6409	D289	2089	89

Disclaimer: Every effort has been made to insure the accuracy of motor data and cross reference information. Design changes may result in different operating characteristics or dimensional changes from one manufacturer to another. Therefore, MARS cannot accept responsibility for the ultimate selection. For additional information, please contact MARS.

Note: B/B – Ball Bearing



Cross Reference / MARS Motors

One-On-One™ Replacement Motors

MARS No.	Description	Copeland	US Motors/Emerson	GE/Genteq	Packard
One-On-One™ Replacement Motor for Copeland					
10227	1/3 HP, Condenser Fan, 208-230 V, 1625 RPM	050-0108-00	6127, K55HXECE2645	5KCP32KG2598, 5KCP32KG175	-
10228	1/6 HP, Condenser Fan, 208-230 V, 1550 RPM	050-0251-00	6128, K55HSJNG-2974	5KCP32KG221	40251
10229	1/4 HP, Condenser Fan, 208-230 V, 1625 RPM	050-0250-00	6129, K55HXJZJ-3126		40250
10264	1/4 HP, Condenser Fan, 230 V, 1550 RPM	050-0238-00, 050-0107-01	6124, K55BZY-1439	5KCP39GG357S	-
10265	1/6 HP, Condenser Fan, 208-230 V, 1550 RPM	050-0265-00	K55PGP5104		40265

MARS No.	Description	Carrier
10234	1/10 HP, 208-230 V, 1100/1, CW OSE	HC33GE233
MARS USA, 5-1/2 inch diam., totally enclosed, ball bearing, capacitor required 5 MFD @ 370V (MARS No. 12005, 12905, 14005), CW Shaft End		

MARS No.	Description	Goodman
10230	1/4 HP, 208-230 V, 1100/1, CCW OSE	0131M00019P
MARS USA, 5-1/2 inch diam., totally enclosed, ball bearing, capacitor required 5 MFD @ 370V (MARS No. 12005, 12905, 14005), CCW Shaft End		
10232	1/6 HP, 208-230 V, 810/1 CCW OSE	0131M00060
MARS USA, 5-1/2 inch diam., totally enclosed, ball bearing, capacitor required 5 MFD @ 370V (MARS No. 12005, 12905, 14005), CCW Shaft End		
03242	1/6 HP, 208-230 V, 1075/1 CCW OSE	G3911
MARS USA, 5 1/2 inch diam. Totally enclosed, ball bearing, capacitor required 5 MFD @ 370V (MARS No. 12005, 12905, 14005), CCW Shaft End		
10233	1/8 HP, 208-230 V, 1050/1 CCW OSE	0131M00294
MARS USA, 5-1/2 inch diam., totally enclosed, ball bearing, capacitor required 5 MFD @ 370V (MARS No. 12005, 12905, 14005), CCW Shaft End		
10594	1/2 HP, 115 V, 1130/4 CW OSE	0131F00022
MARS USA, 5-1/2 inch diam., totally enclosed, ball bearing, capacitor required 20 MFD @ 370V (MARS No. 12014, 12914, 14014), CW Shaft End		

MARS No.	Description	York Source 1
10570	1/3 HP, 575/1/60, 850 RPM, CCW OSE	S1-02434550003
5-1/2 inch diam., totally enclosed, ball bearing, capacitor required, 5 MFD @ 370V (MARS No. 12005, 12905, 14005), CCW OSE		
10571	3/4 HP, 575/1/60, 1100 RPM, CCW OSE	S1-02434551003
5-1/2 inch diam., totally enclosed, ball bearing, capacitor required, 10 MFD @ 440V (MARS No. 12032, 12932, 14032), CCW OSE		

Sunslinger One-On-One™ Replacement Motor

MARS No.	Description	Century/AO Smith
20884	1/8, 1/6, 1/5, 1/4, 1/3 HP, 460 V, 825/1 Reversible	ORM4688BF
5-1/2 inch diam., totally enclosed, ball bearing, capacitor required 7.5 MFD @ 370V (MARS No. 12007, 12907, 14007), Reversible		

Disclaimer: Every effort has been made to insure the accuracy of motor data and cross reference information. Design changes may result in different operating characteristics or dimensional changes from one manufacturer to another. Therefore, MARS cannot accept responsibility for the ultimate selection. For additional information, please contact MARS.

Note: B/B – Ball Bearing

MARS Motors

Replacement Fractional Horsepower Motors
for the HVAC/R Industry

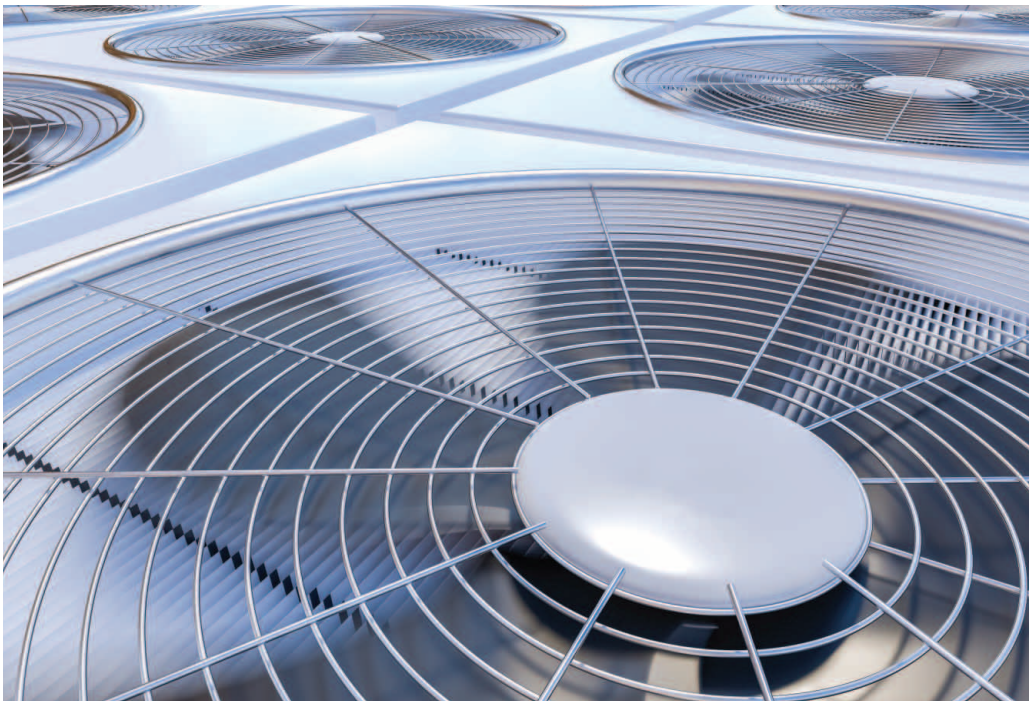

**Technical Helpline:
800.678.9888**

www.marsdelivers.com