

# Components

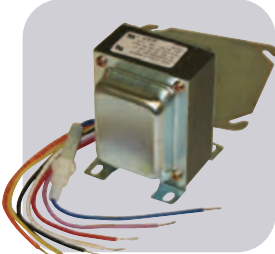

# Table of Contents

Description	Page No.
<b>Capacitors</b>	
Accessories for Capacitors . . . . .	C-9
Motor Run Capacitors . . . . .	C-5 – C-8, C-10
Motor Start Capacitors . . . . .	C-3
Turbo 200™ Universal Motor Run & Start Capacitors . . . . .	C-4
<b>Compressor and Crankcase Heaters</b> . . . . .	C-44 – C-45
<b>Condensate Pumps</b> . . . . .	C-27 – C-28
<b>Contactors</b>	
MARS 780 Dual Purpose Contactors . . . . .	C-11 – C-16
Furnas NEMA Contactors & Starters . . . . .	C-17
GE Definite Purpose Contactors . . . . .	C-18
Magnetic Line Contactors . . . . .	C-20
MARS Definite Purpose Contactors . . . . .	C-19
Universal Contactor Enclosure . . . . .	C-18
<b>Crankcase Heaters</b> . . . . .	C-44
<b>Defrost Thermostats</b> . . . . .	C-41
<b>Electric Heat Coils</b> . . . . .	C-46
<b>Fan Centers</b>	
MARS Fan Centers . . . . .	C-20
<b>Fan &amp; Limit Thermostats</b> . . . . .	C-49 – C-50
<b>Flame Sensors</b> . . . . .	C-52
<b>Heat Pump Thermostats</b> . . . . .	C-43
<b>Hot Surface Igniters (Pilot Burners)</b> . . . . .	C-51
<b>Klixon Motor Protectors</b> . . . . .	C-40

Description	Page No.
<b>Klixon Pressure Switches</b> . . . . .	C-42
<b>Klixon Thermostats</b> . . . . .	C-41
<b>Leak Detectors / Renewal Parts</b> . . . . .	C-36
<b>MARS Motor Protectors</b> . . . . .	C-39
<b>MARS Pressure Switches</b> . . . . .	C-42 – C-43
<b>Relays</b>	
Current Relays . . . . .	C-33
Enclosed Relays . . . . .	C-33
General Purpose Relays . . . . .	C-31
General Purpose Switching Relays . . . . .	C-31 – C-32
MARS Potential Relays . . . . .	C-34 – C-35
<b>Sequencers</b> . . . . .	C-47 – C-48
<b>Solid State Motor Starting Devices</b> . . . . .	C-37
<b>Solid State Timers</b> . . . . .	C-37 – C-38, C-39
<b>Start Assists</b> . . . . .	C-29 – C-30
<b>Surge Protection Devices</b> . . . . .	C-26, C-27
<b>Thermocouples</b> . . . . .	C-50
<b>Transformers</b>	
GE IP Core & Coil Transformers . . . . .	C-23
Jard Transformers . . . . .	C-24 – C-25
MARS Transformers . . . . .	C-21 – C-23

## Electrolytic Capacitors for Motor Starting Applications

Start capacitor case dimensions chart. Capacitor accessories on page C-9.

### Features:

- The largest assortment of replacements in the industry!
- Smallest dimensions for general replacements.
- Hermetically sealed black Bakelite case permanently protects the capacitor from oil, dirt, grease or moisture.
- New and improved terminal construction capable of withstanding increased heat. This terminal will generate less heat when applied under severe hot humid environment.
- 50/60 Hz
- UL/ULc



### 110/125 Dual Voltage AC

MARS NO.	MICROFARAD MIN - MAX.	CASE SIZE
11002	21-25	1
11003	25-30	1
11004	30-36	1
11005	36-43	1
11006	43-56	1
11007	56-72	1
11008	72-88	1
11009	88-108	1
11010	108-130	1
11112	124-156	1
11011	130-156	1
11013	145-175	1
11014	161-193	1
11015	189-227	1
11016	200-240	1
11017	216-259	1
11018	233-292	1
11019	270-324	1
11020	300-360	1
11021	324-388	1
11022	340-408	2
11023	378-440	2
11024	400-480	2
11071	430-516	2
11025	460-552	2
11026	540-648	4
11027	590-708	4
11047	645-774	4
11028	708-850	4
11072	815-970	4
11029	829-995	4
11073	850-1020	4
11030	1000-1200	7
11074	1290-1548	7

MARS suggests applying a bleed resistor (MARS PN 93007) on start capacitors used in conjunction with starting relays

\*Capacitors may be put in different case sizes occasionally, but will not be larger than those stated.

### 165 Volts AC

MARS NO.	MICROFARAD MIN - MAX.	CASE SIZE
11075	72-88	1
11076	88-108	1
11077	108-130	1
11031	124-149	1
11032	145-175	1
11033	161-193	1
11034	189-227	1
11078	216-259	4
11035	233-292	4
11036	270-324	4
11079	340-408	4
11080	378-455	4
11037	400-480	4
11081	540-648	4
11082	710-850	7
11083	810-972	7

### 220/250 Dual Voltage AC

MARS NO.	MICROFARAD MIN - MAX.	CASE SIZE
11038	21-25	1
11039	25-30	1
11040	30-36	1
11041	36-43	1
11042	43-56	1
11043	56-72	1
11084	59-71	1
11137	64-77	4
11044	72-88	4
11045	88-108	4
11046	108-130	4
11148	124-156	4
11049	145-175	4
11050	161-193	6
11051	189-227	6
11052	216-259	6
11053	233-292	6
11054	270-324	6
11085	280-336	7
11086	320-384	7
11087	340-408	7
11088	378-455	7
11089	400-480	7
11090	430-516	7
11091	630-750	8

### 330 Volts AC

MARS NO.	MICROFARAD MIN - MAX.	CASE SIZE
11055	21-25	2
11056	25-30	2
11057	30-36	2
11058	36-43	2
11059	43-56	4
11060	56-72	4
11160	64-77	4
11061	72-88	4
11062	88-108	4
11063	108-130	7
11064	130-156	7
11165	124-156	7
11092	135-162	7
11066	145-175	7
11067	161-193	7
11068	189-227	7
11069	216-259	7
11070	270-324	7
11093	300-360	7

# Turbo Products

## The Turbo Family of Products

### Turbo Family of Products

- Truly Universal Capacitors
- Made in the USA
- Filled with a thick non-PCB dielectric fluid to reduce heat
- Rust free all brass terminals
- 5 Year warranty (3 year warranty on 12700)

### Turbo 200® & Turbo 200®X with CPT®

- Turbo 200® replaces over 200 single or dual values from 2.5 to 67.5 MFD
- Turbo 200®X replaces any of the higher range single or dual capacitors used in scroll compressors and higher efficiency A/C units, values from 5 to 97.5 MFD
- CPT® acts as a kill switch between the hard-start and compressor in the event of a failed run capacitor, preventing damage and possible compressor failure
- Each Turbo 200® and 200X are individually tested and labeled with exact MFD ratings at completion of manufacturing

### Turbo Easy-Start® Hardstart with CPT® Fuse Wire

- Replaces 4 commonly used hard start kits up to 5 tons
- 12600 has a built-in potential relay
- 12700 has an external potential relay
- CPT® Fuse Wire cuts off the motor-start capacitor from AC compressor within 3 seconds of a relay failure, preventing costly damage

### Turbo 200® Mini & Mini-Oval

- A permanent replacement run capacitor for fan size values 2.5 MFD to 15 MFD

### Turbolytic® 50 & Turbolytic® JR

- Turbolytic® 50 is a motor start capacitor that can replace any of the most popular values up to 324 MFD
- The JR is a more compact version that offers combined values up to 227 MFD

MARS NO.	DESCRIPTION	MICROFARAD	VOLTAGE
12100	Turbo 200® Mini	2.5 MFD - 15 MFD	370V or 440V
12500	Turbo 200® Mini - Oval	2.5 MFD - 15 MFD	370V or 440V
12200	Turbo 200®	2.5 MFD - 67.5 MFD	370V or 440V
12300	Turbo 200®X	5.0 MFD - 97.5 MFD	370V or 440V
11200	Turbolytic® 50	23 MFD - 302 MFD	125V to 330V
11100	Turbolytic® JR	23 MFD - 208 MFD	125V to 330V
12600	Turbo Easy-Start® 5 with CPT® Fuse Wire for protection against relay failure	Up to 1 ton 108 - 130 MFD 1 to 2 tons 189 - 227 MFD 2.5 to 3 tons 233 - 280 MFD 3.5 to 5 tons 270 - 324 MFD	Up to 330V
12700	Turbo Easy-Start® 5 EXT with External Potential Relay and CPT® Fuse Wire for protection against relay failure	Up to 1 ton 108 - 130 MFD 1 to 2 tons 189 - 227 MFD 2.5 to 3 tons 233 - 280 MFD 3.5 to 5 tons 270 - 324 MFD	Up to 330V



## MARS Capacitor Tester

### Features:

- Easy to use
- 9V battery and test leads included
- Low battery indicator

MARS NO.	RANGE	RESOLUTION	ACCURACY	TEST FREQUENCY
65746	200 pF	0, 1pF	± (0.5% rdg + 1 dgt + 0.5 pF)	820Hz
	2000 pF	1 pF		
	20 nF	10 pF		
	200 nF	100 pF		
	2 nF	1 nF		
	20 μF	10 nF	± (0.5% rdg + 1 dgt)	
200 μF	-100 nF			
2000 μF	1 μF	± (2.0% rdg. + 1dgt)		
20 mF	10 μF		8.2 Hz	

Single Section Run Capacitors

Capacitor accessories on page C-9.

Features:

- MARS offers the widest selection of ratings in the industry
- Non-PCB capacitors
- Physical interrupter makes our capacitors safe
- Perfect for general replacements—smallest dimensions available
- UL and CSA listings available
- 50/60 Hz

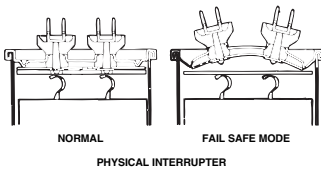

Single Section 370 Volt Round

MARS NO.	MICROFARAD	BASE	HEIGHT IN.
12092	2	M	2.000
12093	3	M	2.000
12094	4	M	2.000
12095	5	M	2.000
12096	6	M	2.000
12097	7.5	M	2.000
12098	10	M	2.000
12099	12.5	M	2.000
12210	15	M	2.375
12211	16	M	2.375
12212	17.5	M	2.375
12214	20	M	2.625
12215	25	M	3.000
12217	30	M	3.000
12218	35	M	3.750
12221	40	M	3.750
12223	45	N	3.375
12225	50	N	3.750
12226	55	N	3.750
12227	60	N	4.750
12128	65	N	4.750
12229	70	N	4.750
12199	80	N	4.750
12116	100	P	4.750

Single Section 440/370 Volt Oval

MARS NO.	MICROFARAD	BASE	HEIGHT IN.
12026	2	A	1.500
12019	2.5	A	1.500
12027	3	A	2.000
12028	4	A	2.000
12029	5	A	2.375
12030	6	A	2.375
12031	7.5	A	2.625
12032	10	A	3.750
12033	12.5	A	3.750
12034	15	C	2.375
12036	17.5	C	2.375
12037	20	C	2.625
12040	25	C	3.000
12041	30	C	3.750
12043	35	C	3.750
12045	40	C	4.750
12048	45	C	4.750
12049	50	C	4.750
12050	55	C	4.750
12051	60	D	3.750
12052	65	D	3.750
12130	70	D	3.750
12135	75	D	3.750
12140	80	D	4.750

Single Section 370 Volt Oval

MARS NO.	MICROFARAD	BASE	HEIGHT IN.
12002	2	A	1.500
12003	3	A	1.500
12004	4	A	1.500
12005	5	A	1.500
12006	6	A	1.500
12007	7.5	A	2.375
12008	10	A	2.625
12009	12.5	A	3.000
12010	15	A	3.750
12012	17.5	A	3.750
12014	20	C	2.375
12015	25	C	2.625
12017	30	C	2.625
12018	35	C	3.000
12021	40	C	3.750
12023	45	C	3.750
12025	50	C	3.750
12024	55	C	4.250
12087	60	C	4.750
12011	65	C	4.750
12089	70	C	4.750
12090	80	D	3.750

Single Section 440/370 Volt Round

MARS NO.	MICROFARAD	BASE	HEIGHT IN.
12102	2	M	2.000
12103	3	M	2.000
12104	4	M	2.000
12105	5	M	2.000
12106	6	M	2.000
12107	7.5	M	2.000
12232	10	M	2.375
12233	12.5	M	2.375
12234	15	M	2.625
12236	17.5	M	2.750
12237	20	M	3.000
12240	25	M	3.750
12241	30	N	3.375
12243	35	N	3.750
12245	40	N	3.750
12248	45	N	4.750
12251	50	P	3.375
12252	55	P	3.750
12254	60	P	3.750
12357	65	P	3.750
12258	70	P	4.750
12259	80	P	4.750
12068	90	P	4.750

# Motor Run Capacitors

## Dual Section Motor Run Capacitors

Dual section run capacitors are used primarily to serve two microfarad applications. They can, however, by making various combinations of parallel connections, be used to obtain many other microfarad ratings.

Capacitor accessories on page C-9.

**Features:**

- MARS offers the widest selections of ratings in the industry
- Non-PCB capacitors
- Physical interrupter makes our capacitors safe
- Perfect for general replacements—smallest dimensions available
- UL and CSA listings available
- 50/60 Hz

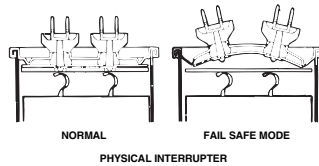

## Dual Section 370 Volt Round

MARS NO.	MICROFARAD	BASE	HEIGHT IN.
12121	15/3	N	3.125
12122	15/4	N	3.125
12203	15/5	N	3.125
12204	15/10	N	3.125
12205	17.5/4	N	3.125
12206	17.5/5	N	3.125
12207	20/4	N	3.125
12260	20/5	N	3.125
12016	20/7.5	N	3.125
12208	20/10	N	3.125
12209	20/15	N	3.125
12242	25/3	N	3.125
12175	25/4	N	3.125
12261	25/5	N	3.125
12262	25/7.5	N	3.125
12213	25/10	N	3.125
12244	30/3	N	3.125
12263	30/4	N	3.125
12264	30/5	N	3.125
12224	30/7.5	N	3.125
12228	30/10	N	3.125
12039	30/15	N	3.875
12082	35/3	N	3.875
12231	35/4	N	3.125
12266	35/5	N	3.875
12235	35/7.5	N	3.125
12238	35/10	N	3.875
12074	40/3	N	3.875
12267	40/4	N	3.875
12178	40/5	N	3.875
12268	40/7.5	N	3.875
12246	40/10	N	3.875
12073	45/3	N	3.875
12247	45/4	N	3.875
12269	45/5	P	3.875
12249	45/7.5	N	3.875
12250	45/10	N	3.875
12075	50/3	P	3.125
12191	50/5	N	3.875
12192	50/7.5	P	3.125
12239	50/10	P	3.875
12193	55/5	N	4.75
12194	55/7.5	N	4.75
12067	55/10	N	4.75
12076	60/3	P	3.875
12195	60/5	P	3.875
12196	60/7.5	N	4.75
12265	60/10	P	3.125
12042	65/5	N	4.75
12053	70/5	P	3.875
12054	70/7.5	P	3.875
12055	70/10	P	3.875
12044	75/5	P	3.875
12046	75/7.5	P	3.875
12084	75/10	P	3.875
12197	80/5	P	3.875
12198	80/7.5	P	3.875
12201	80/10	P	3.875
12202	80/12.5	P	4.75
12129	85/5	P	4.75
12230	85/7.5	P	4.75
12222	85/10	P	4.75

## Dual Section 370 Volt Oval

MARS NO.	MICROFARAD	BASE	HEIGHT IN.
12141	15/3	C	2.625
12056	15/4	C	2.625
12057	15/5	C	2.625
12058	15/10	C	3.000
12059	17.5/4	C	2.375
12060	17.5/5	C	2.375
12061	20/3	C	2.625
12062	20/4	C	2.625
12063	20/5	C	2.625
12064	20/10	C	2.625
12164	20/15	C	4.750
12142	25/3	C	2.625
12065	25/4	C	2.625
12066	25/5	C	2.625
12143	25/7.5	C	2.625
12131	25/8	C	3.000
12167	25/10	C	3.000
12133	25/15	C	3.000
12144	30/3	C	3.000
12145	30/4	C	3.000
12069	30/5	C	3.000
12146	30/7.5	C	3.000
12147	30/10	C	3.375
12148	35/3	C	3.000
12071	35/4	C	3.750
12072	35/5	C	3.750
12149	35/7.5	C	3.000
12150	35/10	C	3.750
12151	40/3	C	3.750
12158	40/4	C	3.750
12171	40/5	C	3.750
12152	40/7.5	C	3.750
12134	40/10	C	3.750
12173	45/3	C	3.750
12174	45/5	C	3.750
12153	45/7.5	C	3.750
12136	45/10	C	4.750
12137	45/15	C	4.750
12138	50/5	C	4.750
12154	55/5	C	4.750
12155	55/7.5	C	4.750
12139	60/5	D	4.750
12156	60/7.5	C	4.750
12157	60/10	C	4.750
12159	65/5	D	4.750
12163	80/5	D	4.750
12123	80/7.5	D	4.750

Dual Section Motor Run Capacitors

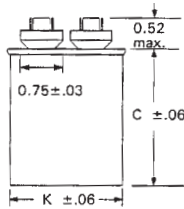
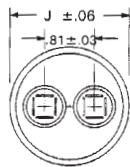
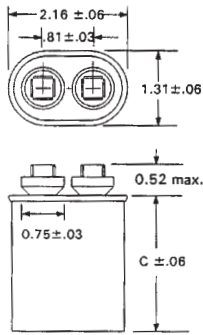

Dual Section 440/370 Volt Oval

MARS NO.	MICROFARAD	BASE	HEIGHT IN.
12360	5/5	C	2.625
12165	10/5	C	3.125
12170	10/10	C	3.125
12270	15/4	C	2.625
12271	15/5	C	2.625
12177	15/10	C	3.750
12180	20/5	C	3.375
12083	20/15	D	3.000
12184	25/5	D	3.000
12182	25/7.5	C	3.750
12183	25/10	C	3.750
12186	25/15	D	3.000
12181	30/4	C	3.750
12187	30/5	D	3.750
12038	30/7.5	C	3.750
12035	30/10	C	3.750
12085	35/3	C	4.750
12179	35/4	C	3.750
12185	35/5	C	4.750
12188	35/7.5	C	3.750
12176	35/8.5	C	3.750
12272	35/10	C	4.750
12080	40/3	C	4.750
12086	40/5	C	4.750
12189	40/7.5	C	4.750
12273	40/10	C	4.750
12190	45/5	D	4.750
12274	45/7.5	C	4.750
12108	50/5	D	4.750
12013	50/7.5	C	4.750
12275	55/5	D	4.750
12276	55/10	D	4.750
12109	60/5	D	4.750
12110	60/7.5	D	4.750
12101	65/10	D	4.750
12297	80/5	D	5.750
12298	80/7.5	D	5.750

Dual Section 440/370 Volt Round

MARS NO.	MICROFARAD	BASE	HEIGHT IN.
12111	10/5	N	3.125
12118	15/5	N	3.125
12356	15/10	N	3.125
12350	17.5/5	N	3.125
12115	20/5	N	3.125
12354	20/7.5	N	3.125
12351	20/10	N	3.875
12112	20/15	N	3.875
12353	25/3	N	3.875
12355	25/4	N	3.875
12278	25/5	N	3.875
12279	25/7.5	N	3.875
12113	25/10	N	3.625
12114	25/15	N	3.875
12126	30/3	N	3.875
12120	30/4	N	3.875
12281	30/5	N	3.875
12282	30/7.5	N	3.875
12352	30/10	N	4.750
12077	35/3	N	3.875
12070	35/4	N	3.875
12283	35/5	N	3.875
12119	35/6	N	4.750
12284	35/7.5	P	3.875
12091	35/10	N	4.750
12078	40/3	P	3.125
12285	40/4	P	3.125
12286	40/5	P	3.125
12220	40/6	N	4.750
12287	40/7.5	P	3.875
12088	40/10	N	4.750
12079	45/3	P	3.875
12219	45/4	N	3.750
12288	45/5	P	3.875
12127	45/6	N	4.750
12289	45/7.5	N	3.875
12172	45/10	P	3.875
12290	50/5	P	3.875
12291	50/7.5	P	3.875
12124	50/10	P	3.875
12253	50/12.5	P	3.875
12292	55/5	P	3.875
12293	55/7.5	P	3.875
12299	55/10	P	3.875
12160	60/3	P	4.750
12294	60/5	P	3.875
12295	60/7.5	P	3.875
12296	60/10	P	3.875
12161	60/12.5	P	4.750
12358	65/5	P	4.750
12359	65/7.5	P	4.750
12162	65/10	P	4.750
12255	70/5	P	4.750
12166	70/7.5	P	4.750
12169	70/10	P	4.750
12168	75/5	P	4.750
12125	75/7.5	P	4.750
12047	75/10	P	4.750
12257	80/5	P	4.875
12216	80/7.5	P	4.750
12117	80/10	P	4.750
12022	85/5	P	4.750
12020	85/7.5	P	4.750
12001	85/10	P	4.750

Capacitor Base Dimensions

Base Dimension Key - Oval

KEY	WIDTH	LENGTH	DESCRIPTION
A	1.31	2.16	oval fan size
C	1.91	2.91	oval
D	1.97	3.66	oval

Base Dimension Key - Round

KEY	WIDTH	MOUNTING STRAP
M	1.75	93031
N	2.00	93032
P	2.50	93033

# USA Motor Run Capacitors

## MARS USA Capacitors

### Features:

- Product of USA
- Tested and approved by every major US motor company and compressor company
- 440/370 Dual Voltage Rated
- Non-PCB capacitors
- Physical interrupter makes our capacitors safe
- Meets EIA-456A Test Standard (simulates 60,000 hours of operation)
- Meets Tecumseh H-115
- OEM Grade
- CSA approved and UL recognized
- 5 year warranty



### Single Section 370 Volt Oval

MARS USA NO.	DESCRIPTION	BASE HEIGHT
14002	2 MFD 370V OVL	A 1.50
14003	3 MFD 370V OVL	A 1.50
14004	4 MFD 370V OVL	A 1.50
14005	5 MFD 370V OVL	A 1.50
14006	6 MFD 370V OVL	A 1.50
14007	7.5 MFD 370V OVL	A 2.38
14008	10 MFD 370V OVL	A 2.63
14009	12.5 MFD 370V OVL	A 3.00
14010	15 MFD 370V OVL	A 3.75
14012	17.5 MFD 370V OVL	A 3.75
14014	20 MFD 370V OVL	C 2.38
14015	25 MFD 370V OVL	C 2.63
14017	30 MFD 370V OVL	C 2.63
14018	35 MFD 370V OVL	C 3.00
14021	40 MFD 370V OVL	C 3.75
14023	45 MFD 370V OVL	C 3.75
14025	50 MFD 370V OVL	C 3.75
14024	55 MFD 370V OVL	C 4.25
14087	60 MFD 370V OVL	C 4.75
14089	70 MFD 370V OVL	C 4.75
14090	80 MFD 370V OVL	D 3.75

### Single Section 370 Volt Round

MARS USA NO.	DESCRIPTION	BASE HEIGHT
14095	5 MFD 370V RND	M 2.00
14098	10 MFD 370V RND	M 2.00
14099	12.5 MFD 370V RND	M 2.00
14210	15 MFD 370V RND	M 2.38
14212	17.5 MFD 370V RND	M 2.38
14214	20 MFD 370V RND	M 2.65
14215	25 MFD 370V RND	M 3.00
14217	30 MFD 370V RND	M 3.00
14218	35 MFD 370V RND	M 3.75
14821	40 MFD 370V RND	M 3.75
14823	45 MFD 370V RND	N 3.38
14225	50 MFD 370V RND	N 3.75
14226	55 MFD 370V RND	N 3.75
14227	60 MFD 370V RND	N 4.75
14128	65 MFD 370V RND	N 4.75
14229	70 MFD 370V RND	N 4.75
14199	80 MFD 370V RND	N 4.75
14116	100 MFD 370V RND	P 4.75

### Single Section 440/370 Volt Round

MARS USA NO.	DESCRIPTION	BASE HEIGHT
14102	2 MFD 440/370V RND	M 2.00
14103	3 MFD 440/370V RND	M 2.00
14104	4 MFD 440/370V RND	M 2.00
14105	5 MFD 440/370V RND	M 2.00
14106	6 MFD 440/370V RND	M 2.00
14107	7.5 MFD 440/370V RND	M 2.00
14232	10 MFD 440/370V RND	M 2.38
14833	12.5 MFD 440/370V RND	M 2.38
14234	15 MFD 440/370V RND	M 2.63
14237	20 MFD 440/370V RND	M 3.00
14240	25 MFD 440/370V RND	M 3.75
14241	30 MFD 440/370V RND	N 3.38
14243	35 MFD 440/370V RND	N 3.75
14245	40 MFD 440/370V RND	N 3.75
14248	45 MFD 440/370V RND	N 4.75
14251	50 MFD 440/370V RND	P 3.38
14252	55 MFD 440/370V RND	P 3.75
14254	60 MFD 440/370V RND	P 3.75
14256	65 MFD 440/370V RND	P 3.75
14258	70 MFD 440/370V RND	P 4.75
14259	80 MFD 440/370V RND	P 4.75

### Single Section 440/370 Volt Oval

MARS USA NO.	DESCRIPTION	BASE HEIGHT
14026	2 MFD 440/370V OVL	D 1.50
14027	3 MFD 440/370V OVL	A 2.00
14028	4 MFD 440/370V OVL	A 2.00
14029	5 MFD 440/370V OVL	A 2.38
14030	6 MFD 440/370V OVL	A 2.38
14031	7.5 MFD 440/370V OVL	A 2.63
14032	10 MFD 440/370V OVL	A 3.75
14033	12.5 MFD 440/370V OVL	A 3.75
14034	15 MFD 440/370V OVL	C 2.38
14036	17.5 MFD 440/370V OVL	C 2.38
14037	20 MFD 440/370V OVL	C 2.63
14040	25 MFD 440/370V OVL	C 3.00
14041	30 MFD 440/370V OVL	C 3.38
14043	35 MFD 440/370V OVL	C 3.75
14045	40 MFD 440/370V OVL	C 4.75
14048	45 MFD 440/370V OVL	C 4.75
14049	50 MFD 440/370V OVL	C 4.75
14050	55 MFD 440/370V OVL	C 4.75
14051	60 MFD 440/370V OVL	D 3.75
14130	70MFD 440/370V OVL	D 3.75
14140	80 MFD 440/370V OVL	D 4.75

### Dual Section 370 Volt Oval

MARS USA NO.	DESCRIPTION	BASE HEIGHT
14063	20/5 MFD 370V OVL	C 2.63
14066	25/5 MFD 370V OVL	C 2.63
14069	30/5 MFD 370V OVL	C 3.00
14072	35/5 MFD 370V OVL	C 3.75
14171	40/5 MFD 370V OVL	C 3.75
14174	45/5 MFD 370V OVL	C 3.75

### Dual Section 440/370 Volt Oval

MARS USA NO.	DESCRIPTION	BASE HEIGHT
14170	10/10 MFD 440/370V OVL	C 2.63
14184	25/5 MFD 440/370V OVL	C 3.75
14187	30/5 MFD 440/370V OVL	D 3.75
14085	35/3 MFD 440/370V OVL	C 4.75
14185	35/5 MFD 440/370V OVL	C 4.75
14188	35/7.5 MFD 440/370V OVL	C 3.75
14086	40/5 MFD 440/370V OVL	C 4.75
14189	40/7.5MFD 440/370V OVL	C 4.75
14190	45/5 MFD 440/370V OVL	D 4.75
14274	45/7.5 MFD 440/370V OVL	C 4.75
14275	55/5 MFD 440/370V OVL	D 4.75
14297	80/5 MFD 440/370V OVL	D 5.75
14298	80/7.5MFD 440/370V OVL	D 5.75

### Dual Section 370 Volt Round

MARS USA NO.	DESCRIPTION	BASE HEIGHT
14260	20/5 MFD 370V RND	N 2.63
14208	20/10 MFD 370V RND	N 3.13
14261	25/5 MFD 370V RND	N 2.63
14213	25/10 MFD 370V RND	N 3.13
14244	30/3 MFD 370 RND	N 3.13
14263	30/4 MFD 370V RND	N 3.13
14082	35/3 MFD 370V RND	N 3.88
14131	35/4 MFD 370V RND	N 3.13
14264	30/5 MFD 370V RND	N 3.13
14266	35/5 MFD 370V RND	N 3.88
14238	35/10 MFD 370V RND	N 3.88
14178	40/5 MFD 370V RND	N 3.88
14268	40/7.5 MFD 370V RND	N 3.88
14246	40/10 MFD 370V RND	N 3.88
14073	45/3 MFD 370V RND	N 3.88
14269	45/5 MFD 370V RND	P 3.88
14249	45/7.5 MFD 370V RND	N 3.88
14250	45/10 MFD 370V RND	N 3.88
14075	50/3 MFD 370V RND	P 3.13
14191	50/5 MFD 370V RND	N 3.88
14192	50/7.5 MFD 370V RND	P 3.13
14239	50/10 MFD 370V RND	P 3.88
14193	55/5MFD 370V RND	N 4.75
14194	55/7.5 MFD 370V RND	N 4.75
14195	60/5 MFD 370V RND	P 3.88
14196	60/7.5 MFD 370V RND	N 4.75
14265	60/10 MFD 370V RND	P 3.88
14042	65/5 MFD 370V RND	N 4.75
14053	70/5 MFD 370V RND	P 3.88
14054	70/7.5 MFD 370V RND	P 3.88
14197	80/5 MFD 370V RND	P 3.88
14198	80/7.5 MFD 370V RND	P 3.88
14201	80/10 MFD 370V RND	P 3.88

### Dual Section 440/370 Volt Round

MARS USA NO.	DESCRIPTION	BASE HEIGHT
14115	20/5 MFD 440/370V RND	N 3.13
14353	25/3 MFD 440/370V RND	N 3.88
14278	25/5 MFD 440/370V RND	N 3.88
14279	25/7.5 MFD 440/370V RND	N 3.88
14113	25/10 MFD 440/370V RND	N 3.88
14126	30/3 MFD 440/370V RND	N 3.88
14281	30/5 MFD 440/370V RND	N 3.88
14282	30/7.5 MFD 440/370V RND	N 3.88
14352	30/10 MFD 440/370V RND	N 4.75
14077	35/3 MFD 440/370V RND	N 3.88
14070	35/4 MFD 440/370V RND	N 3.88
14283	35/5 MFD 440/370V RND	N 3.88
14284	35/7.5 MFD 440/370V RND	P 3.88
14091	35/10 MFD 440/370V RND	N 4.75
14078	40/3 MFD 440/370V RND	P 3.13
14286	40/5 MFD 440/370V RND	P 3.13
14287	40/7.5 MFD 440/370V RND	P 3.88
14088	40/10 MFD 440/370V RND	N 4.75
14079	45/3 MFD 440/370V RND	P 3.88
14288	45/5 MFD 440/370V RND	P 3.88
14289	45/7.5 MFD 440/370V RND	N 3.88
14172	45/10 MFD 440/370V RND	P 3.88
14290	50/5 MFD 440/370V RND	P 3.88
14291	50/7.5 MFD 440/370V RND	P 3.88
14124	50/10 MFD 440/370V RND	P 3.88
14299	55/10 MFD 440/370V RND	P 3.88
14292	55/5 MFD 440/370V RND	P 3.88
14293	55/7.5 MFD 440/370V RND	P 3.88
14294	60/5 MFD 440/370V RND	P 3.88
14295	60/7.5 MFD 440/370V RND	P 3.88
14296	60/10 MFD 440/370V RND	P 3.88
14358	65/5 MFD 440/370V RND	P 3.875
14359	65/7.5 MFD 440/370V RND	P 3.875
14162	65/10 MFD 440/370V RND	P 4.75
14255	70/5 MFD 440/370V RND	P 4.75
14166	70/7.5 MFD 440/370V RND	P 4.75
14169	70/10 MFD 440/370V RND	P 4.75
14168	75/5 MFD 440/370V RND	P 4.75
14125	75/7.5 MFD 440/370V RND	P 4.75
14047	75/10 MFD 440/370V RND	P 4.75
14257	80/5 MFD 440/370V RND	P 4.88
14216	80/7.5 MFD 440/370V RND	P 4.75
14117	80/10 MFD 440/370V RND	P 4.75

### Capacitor Base Dimensions

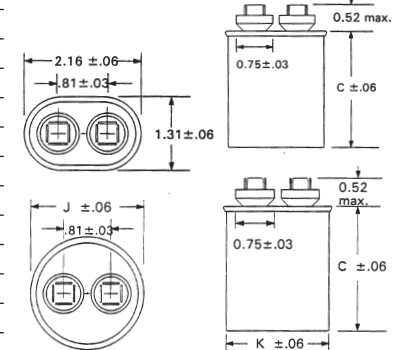

Base Dimension on page C-7



## MARS Mini-Split Run Capacitors

MARS mini-split motor run capacitors are epoxy/resin sealed and widely used as the start-up and/or run capacitor for your motor. They feature very small dissipation factor and inherent temperature rise, high insulation resistance, and stable capacitance.

### Specifications:

- Ambient temperature: 70° C
- Rated voltage: 450 VA
- Capacitance tolerance: ±5
- 50/60 Hz
- Standard: IEC252-2001

MARS NO.	DESCRIPTION	DIMENSIONS		
		H	D	W
12380	1 MFD X 450V	1-1/2	X 1/2	X 1
12381	1.5 MFD X 450V	1-1/2	X 1/2	X 1
12382	2 MFD X 450V	1-1/2	X 1/2	X 1
12383	2.5 MFD X 450V	1-1/2	X 3/4	X 1-1/4
12384	3 MFD X 450V	1-1/2	X 3/4	X 1-1/4
12385	3.5 MFD X 450V	1-7/8	X 3/4	X 1-3/8
12386	4 MFD X 450V	1-7/8	X 3/4	X 1-3/8
12388	5 MFD X 450V	1-7/8	X 7/8	X 1-3/8
12390	6 MFD X 450V	1-7/8	X 1	X 1-1/2



## Accessories For Relays & Capacitors

### QC-6 Kit

**93001** For conversion of screw-type connections on relays

### Resistor for Start Capacitors

**93007** 2 watt (15,000 ohm) Resistors, 10/Pk

### QC-13 for Start Capacitors

**93106** 10 pc 2 watt (15,000 ohm) resistors with .25-in female spade connectors, 10/Pk

### Snap-on Mounting Brackets for Motor Start Capacitors

**93026** 2.75 in  
**93027** 3.38 in  
**93028** 4.38 in  
 Sold in 10 pack

### Start Capacitor Case Dimensions\*

CASE SIZE	DIAMETER	LENGTH
1	1.44	2.75
2	1.44	3.38
4	1.81	3.38
5	1.81	4.38
6	2.06	3.38
7	2.06	4.38
8	2.56	4.38

\*Capacitors may be put in different case sizes occasionally, but will not be larger than those stated.

### Protector (boots) for Motor Run Capacitors

**93011** 1 Hole Boot, 25/Pk

**93012** 2 Hole Boot, 25/Pk

### Wrap-Around Brackets for Motor Run Capacitors

**93014** Oval 1.94 x 2.78 for base A, 10/Pk

**93015** Oval 1.97 x 2.94 for base C, 10/Pk

**93116** Oval 2.25 x 3.66 for base D, 10/Pk

### Mounting Brackets for Round Capacitors

**93031** For 1.63 in and 1.75 in diam  
**93032** For 2.0 in diam  
**93033** For 2.50 in diam  
 Sold in 5 pack

### Bakelite End Caps for Motor Start Capacitors

**93018** BEC-1 1.44 in  
**93019** BEC-2 1.81 in  
**93020** BEC-3 2.06 in  
**93021** BEC-4 2.56 in  
 Sold in 10 pack

For mounting OFF MOTOR. Leads on top side.

**93023** TEC-2 1.81 in  
**93024** TEC-3 2.06 in  
**93025** TEC-4 2.56 in  
 Sold in 10 pack

# Motor Run Capacitors

## Single Section Run Capacitors

370 VOLT				
MFD	OVAL MARS NO.	ROUND MARS NO.	OVAL JARD NO.	ROUND JARD NO.
2	12002	12092	12902	12992
3	12003	12093	12903	12993
4	12004	12094	12904	12994
5	12005	12095	12905	12995
6	12006	12096	12906	12996
7.5	12007	12097	12907	12997
10	12008	12098	12908	12998
12.5	12009	12099	12909	12999
15	12010	12210	12910	12710
16		12211		12911
17.5	12012	12212	12912	12712
20	12014	12214	12914	12714
25	12015	12215	12915	12715
30	12017	12217	12917	12717
35	12018	12218	12918	12718
40	12021	12221	12921	12721
45	12023	12223	12923	12723
50	12025	12225	12925	12725
55	12024	12226	12924	12726
60	12087	12227	12987	12727
65	12011	12128	12988	12828
70	12089	12229	12989	12729
80	12090	12199	12990	12899
100		12116		12916

440/370 VOLT				
MFD	OVAL MARS NO.	ROUND MARS NO.	OVAL JARD NO.	ROUND JARD NO.
2	12026	12102	12926	12802
2.5	12019		12919	
3	12027	12103	12927	12803
4	12028	12104	12928	12804
5	12029	12105	12929	12805
6	12030	12106	12930	12806
7.5	12031	12107	12931	12807
10	12032	12232	12932	12732
12.5	12033	12233	12933	12733
15	12034	12234	12934	12734
17.5	12036	12236	12936	12736
20	12037	12237	12937	12737
25	12040	12240	12940	12740
30	12041	12241	12941	12741
35	12043	12243	12943	12743
40	12045	12245	12945	12745
45	12048	12248	12948	12748
50	12049	12251	12949	12751
55	12050	12252	12950	12752
60	12051	12254	12951	12754
65	12052	12357	12952	12657
70	12130	12258	12830	12758
75	12135		12831	
80	12140	12259	12840	12759
90		12068		12868

## Dual Section Run Run Capacitors

370 VOLT				
MFD	OVAL MARS NO.	ROUND MARS NO.	OVAL JARD NO.	ROUND JARD NO.
15/3	12141	12121	12841	12701
15/4	12056	12122	12956	12702
15/5	12057	12203	12957	12703
15/10	12058	12204	12958	12704
17.5/4	12059	12205	12959	12705
17.5/5	12060	12206	12960	12706
20/3	12061		12961	
20/4	12062	12207	12962	12707
20/5	12063	12260	12963	12760
20/7.5		12016		12716
20/10	12064	12208	12864	12708
20/15	12164	12209	12964	12709
25/3	12142	12242	12842	12711
25/4	12065	12175	12965	12875
25/5	12066	12261	12966	12761
25/7.5	12143	12262	12843	12762
25/8	12131		12832	
25/10	12167	12213	12867	12713
25/15	12133		12833	
30/3	12144	12244	12844	12720
30/4	12145	12263	12845	12763
30/5	12069	12264	12969	12764
30/7.5	12146	12224	12846	12724
30/10	12147	12228	12847	12728
30/15		12039		12939
35/3	12148	12082	12848	12730
35/4	12071	12231	12971	12731
35/5	12072	12266	12972	12766
35/7.5	12149	12235	12849	12735
35/10	12150	12238	12850	12738
40/3	12151	12074	12851	12739
40/4	12158	12267	12858	12767
40/5	12171	12178	12871	12878
40/7.5	12152	12268	12852	12768
40/10	12134	12246	12834	12746
45/3	12173	12073		12747
45/4		12247		12947
45/5	12174	12269	12874	12769
45/7.5	12153	12249	12853	12749
45/10	12136	12250	12836	12750
45/15	12137		12837	
50/3		12075		12753
50/5	12138	12191	12838	12755
50/7.5		12192		12825
50/10		12239		12757
55/5	12154	12193	12854	12893
55/7.5	12155	12194	12855	12894
55/10		12067		12967
60/3		12076		12976
60/5	12139	12195	12839	12895
60/7.5	12156	12196	12856	12896
60/10	12157	12265	12857	12865
65/5	12159	12042	12859	12742
70/5		12053		12953
70/7.5		12054		12954
70/10		12055		12955
75/5		12044		12744
75/7.5		12046		12946
75/10		12084		12984
80/5	12163	12197	12863	12897
80/7.5	12123	12198	12817	12819
80/10		12201		12824
80/12.5		12202		12722
85/5		12129		12829
85/7.5		12230		12756
85/10		12222		12922

## Dual Section Run Run Capacitors

440/370 VOLT				
MFD	OVAL MARS NO.	ROUND MARS NO.	OVAL JARD NO.	ROUND JARD NO.
10/5	12165	12111	12765	12811
15/4	12270		12770	
15/5	12271	12118	12771	12818
15/10	12177	12356	12777	12656
17.5/5		12350		12650
20/5	12180	12115	12880	12780
20/7.5		12354		12654
20/10		12351		12651
20/15	12083	12112	12983	12812
25/3		12353		12653
25/4		12355		12655
25/5	12184	12278	12884	12778
25/7.5	12182	12279	12882	12779
25/10	12183	12113	12883	12813
25/15	12186	12114	12886	12814
30/3		12126		12826
30/4	12181	12120	12881	12820
30/5	12187	12281	12887	12781
30/7.5	12038	12282	12982	12782
30/10	12035	12352	12835	12652
35/3	12085	12077	12985	12977
35/4	12179	12070	12879	12870
35/5	12185	12283	12885	12783
35/6		12119		
35/7.5	12188	12284	12888	12784
35/8.5	12176		12876	
35/10	12272	12091	12772	12797
40/3	12080	12078	12877	12978
40/4		12285		12785
40/5	12086	12286	12986	12786
40/6		12220		12920
40/7.5	12189	12287	12889	12787
40/10	12273	12088	12773	12798
45/3		12079		12979
45/4		12219		12891
45/5	12190	12288	12890	12788
45/6		12127		12827
45/7.5	12274	12289	12774	12789
45/10		12172		12872
50/5	12108	12290	12808	12790
50/7.5	12013	12291	12913	12791
50/10		12124		12892
50/12.5		12253		12719
55/5	12275	12292	12775	12792
55/7.5		12293		12793
55/10	12276	12299	12822	12799
60/3		12160		12860
60/5	12109	12294	12809	12794
60/7.5	12110	12295	12776	12795
60/10		12296		12796
60/12.5		12161		12861
65/5		12358		12642
65/7.5		12359		12659
65/10	12101	12162	12810	12862
70/5		12255		12823
70/7.5		12166		12866
70/10		12169		12869
75/5		12168		12968
75/7.5		12125		12901
75/10		12047		12935
80/5	12297	12257	12815	12801
80/7.5	12298	12216	12898	12816
80/10		12117		12821
85/5		12022		12938
85/7.5		12020		12942
85/10		12001		12944

## MARS 780 Definite Purpose Contactors

MARS 780 - 1 pole with shunt contactors are designed for demanding applications. The enclosed body design provides quiet operation and improved durability by reducing the intrusion of dust and dirt. Silver-cadmium oxide contacts provide increased contact life when switching inductive loads.

### Features:

- Enclosed body and coil – standard cover
- Push to test button
- Quad quick connects
- Box lugs - large window arch design
- Screw terminals and or box lugs available on 30 amp
- Coils - class F insulation
- UL File E96705



### 1 Pole with Shunt 30 - 40 Amps

MARS NO.	FURNAS NO.	LOCKED ROTOR AMPS		NON INDUCTIVE AMPS	COIL VOLTS	TERMINATION
		FLA	240V 277V			
61320	45EG10AJA, 45CG10AJA, 45DG10AJA	30	180	180	40	Screw Type
61321	45EG10AFA, 45CG10AFA, 45DG10AFA					
61322	45EG10AGA, 45CG10AGA, 45DG10AGA					
61323	45EG10ALA, 45CG10ALA, 45DG10ALA					
61720	45EG10AJAL					
61721	45EG10AFAL	30	180	180	40	Box Lug
61722	45EG10AGAL					
61723	45EG10ALAL					
61724	45EG10AHAL					
61730	45GG10AJAL, 45FG10AJA, 45GG10AJA					
61731	45GG10AFAL, 45FG10AFA, 45GG10AFA	40	240	240	50	Box Lug
61732	45GG10AGAL, 45FG10AGA, 45GG10AGA					
61733	45GG10ALAL, 45FG10ALA, 45GG10ALA					
61734	45GG10AHAL, 45FG10AHA, 45GG10AHA					

## MARS 780 Definite Purpose Contactors

MARS 780 - 2 pole contactors are designed for demanding applications. The enclosed body design provides quiet operation and improved durability by reducing the intrusion of dust and dirt. Silver-cadmium oxide contacts provide increased contact life when switching inductive loads.

### Features:

- Enclosed body and coil – standard cover
- Push to test button
- Quad quick connects
- Box lugs - large window arch design
- Screw terminals and or box lugs available on 30 amp
- Coils - class F insulation
- UL File E96705



### 2 Pole 30 - 40 Amps

MARS NO.	FURNAS NO.	LOCKED ROTOR AMPS			NON INDUCTIVE AMPS	COIL VOLTS	TERMINATION
		FLA	240V	480V 600V			
61345	45EG20AJ, 45CG20AJ, 45DG20AJ	30	180	150	120	40	Screw Type
61346	45EG20AF, 45CG20AF, 45DG20AF						
61347	45EG20AG, 45CG20AG, 45DG20AG						
61348	45EG20AL, 45CG20AL, 45DG20AL						
61349	45EG20AH, 45CG20AH, 45DG20AH						
61745	45EG20AJL	30	180	150	120	40	Box Lug
61746	45EG20AFL						
61747	45EG20AGL						
61748	45EG20ALL						
61749	45EG20AHL						
61755	45GG20AJL, 45FG20AJ, 45GG20AJ	40	240	200	160	50	Box Lug
61756	45GG20AFL, 45FG20AF, 45GG20AF						
61757	45GG20AGL, 45FG20AG, 45GG20AG						
61758	45GG20ALL, 45FG20AL, 45GG20AL						
61759	45GG20AHL, 45FG20AH, 45GG20AH						

# MARS 780 Definite Purpose Contactors

## MARS 780 Definite Purpose Contactors

MARS 780 - 2 pole "Large Body" contactors feature a 2 pole configuration in a 3 pole body for increased durability in demanding applications.

**Features:**

- Large arch window box lugs
- Recessed push to test button
- Accepts MARS 780 and Furnas auxiliary switches
- Use standard MARS 780 replacement coils
- Dual QC coil terminals plus screw terminal for easy termination and jumper arrangements
- Coils - class F insulation
- UL File E96705



### 2 Pole - Large Body 30 - 40 Amp

MARS NO.	FURNAS NO.	FLA	LOCKED ROTOR AMPS			NON INDUCTIVE AMPS	COIL VOLTS	HORSEPOWER		TERMINATION
			240V	480V	600V			1 PH 240V	3 PH 240V	
61425	42BF15AJ, 42AF15AJ	30	180	150	120	40	24	3 HP	7.5 HP	Box Lug
61426	42BF15AF, 42AF15AF						120			
61427	42BF15AG, 42AF15AG						208-240			
61428	42BF15AL, 42AF15AL						277			
61440	42CF15AJ	40	240	200	160	50	24	5 HP	10 HP	Box Lug
61441	42CF15AF						120			
61442	42CF15AG						208-240			
61443	42CF15AL						277			

## MARS 780 - 3 Pole Contactors

MARS 780 - 3 pole contactors are designed for demanding applications. The enclosed body design provides quiet operation and improved durability by reducing the intrusion of dust and dirt. Side attachment rails for auxiliary switches (30-60 amp contactors) allow attachment of MARS 780 or Furnas auxiliary switches. Silver-cadmium oxide contacts provide increased contact life when switching inductive loads.

### Features:

- Large arch window box lugs
- SEMS screws or box lugs available on 30 amp contactors
- Recessed push to test button (not on 75 and 90 amp contactors)
- Enclosed body design
- Accepts MARS 780 and Furnas auxiliary switches
- Use standard MARS 780 replacement coils
- Dual QC coil terminals plus screw terminal for easy termination and jumper arrangements
- Coils - class F insulation • 600 volt rating • Foot print compatible
- UL File E96705



### 3 Pole 30 - 90 Amp

\* For 25 Amp Contactors - Use 30 Amp in Place of 25Amp

MARS NO.	FURNAS NO.	FLA	LOCKED ROTOR AMPS			NON INDUCTIVE AMPS	COIL VOLTS	HORSEPOWER				TERMINATION
			240V	480V	600V			1 PH 240V	240V	3 PH 480V	600V	
61430*	42BF35AJ	30	180	150	120	40	24	3 HP	7.5 HP	10 HP	15 HP	Screw Type
61431*	42BF35AF						120					
61432*	42BF35AG						208-240					
61433*	42BF35AL						277					
61434*	42BF35AH						480					
61750	-	30	180	150	120	40	24	3 HP	7.5 HP	10 HP	15 HP	Box Lug
61751	-						120					
61752	-						208-240					
61753	-						277					
61754	-						480					
61445	42CF35AJ	40	240	200	160	50	24	5 HP	10 HP	15 HP	20 HP	Box Lug
61446	42CF35AF						120					
61447	42CF35AG						208-240					
61448	42CF35AL						277					
61449	42CF35AH						480					
61460	42DF35AJ	50	300	250	200	63	24	5 HP	15 HP	20 HP	25 HP	Box Lug
61461	42DF35AF						120					
61462	42DF35AG						208-240					
61463	42DF35AL						277					
61464	42DF35AH						480					
61470	42EF35AJ	60	360	300	240	75	24	7.5 HP	20 HP	25 HP	30 HP	Box Lug
61471	42EF35AF						120					
61472	42EF35AG						208-240					
61473	42EF35AL						277					
61474	42EF35AH						480					
61480	42FE35AJ106	75	450	375	300	94	24	15 HP	25 HP	40 HP	40 HP	Box Lug
61481	42FE35AF106						120					
61482	42FE35AG106						208-240					
61483	42FE35AL106						277					
61484	42FE35AH106						480					
61490	42GE35AJ106	90	540	450	360	120	24	15 HP	30 HP	50 HP	50 HP	Box Lug
61491	42GE35AF106						120					
61492	42GE35AG106						208-240					
61493	42GE35AL106						277					
61494	42GE35AH106						480					

# MARS 780 Definite Purpose Contactors

## 30-40A 1 Pole with Shunt

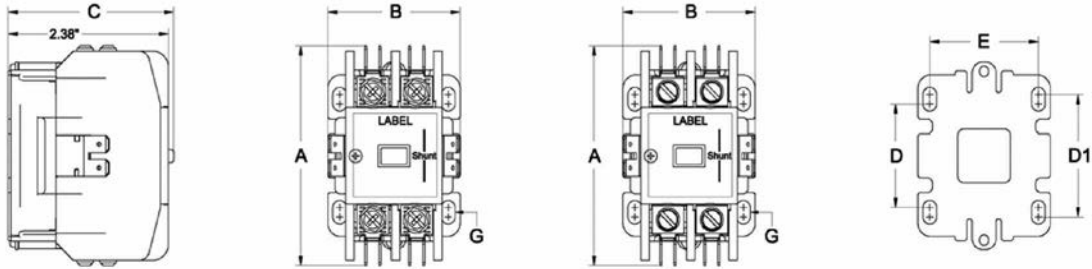

## 30-40A 2 Pole

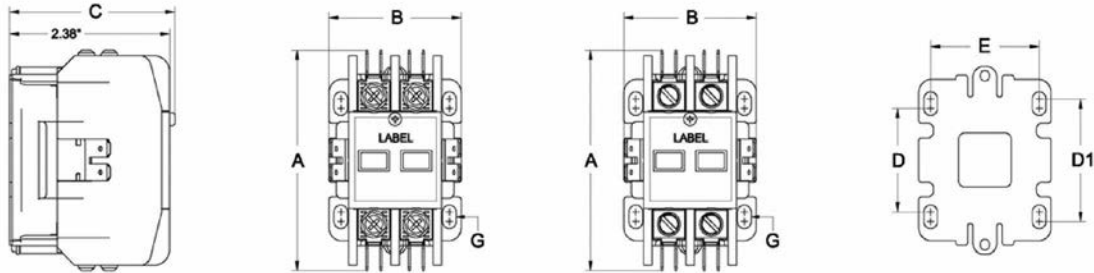

## 30-40A 2\* Pole & 3 Pole

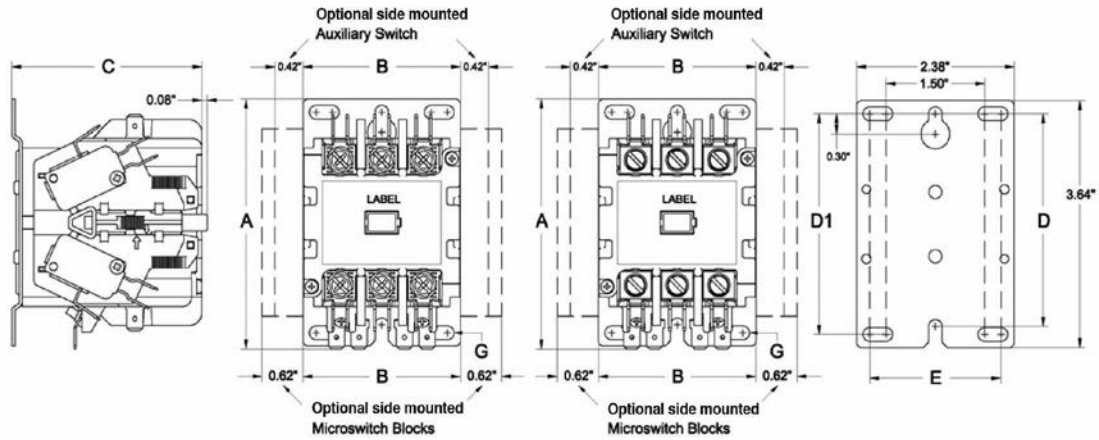

Note - 2\* Pole is a 3 pole body with center contacts removed.

MARS NO.	FLA	POLES	A	B	C	D	D1	E	MTG SCREW G	MAX WIRE SIZE
61320-61323	30	1	3.19	1.97	2.46	1.5	1.77	1.61	10	8
61720-61724 61730-61734	30-40	1	3.19	1.97	2.46	1.5	1.77	1.61	10	4
61345-61349	30	2	3.19	1.97	2.46	1.5	1.77	1.61	10	8
61745-61749 61755-61759	30-40	2	3.19	1.97	2.46	1.5	1.77	1.61	10	4
61430-61434	30	3	3.69	2.38	2.87	3.13	3.25	1.98	10	8
61750-61754 61445-61449	30-40	3	3.69	2.38	2.87	3.13	3.25	1.98	10	4
61425-61428 61440-61443	30-40	2(at 3P)*	3.69	2.38	2.87	3.13	3.25	1.98	10	4

## 50-60A 3 Pole

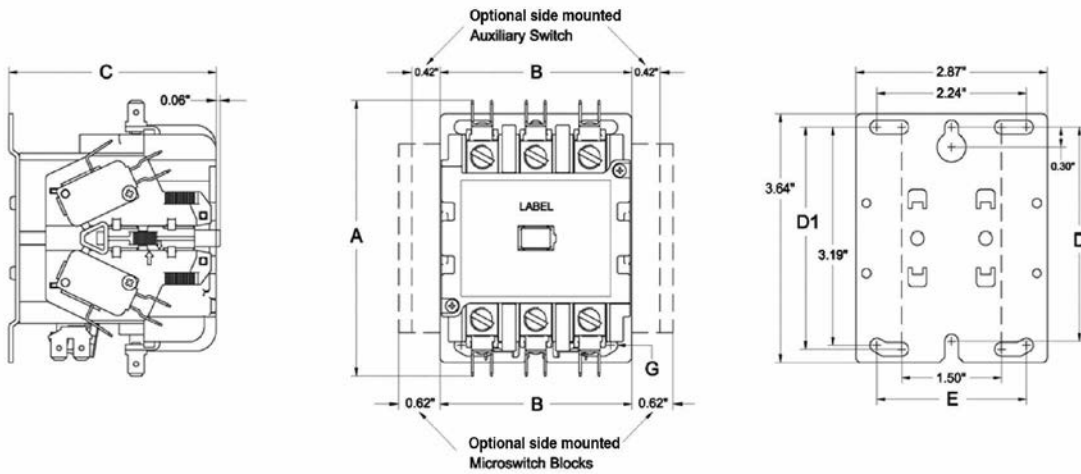

## 75-90A 3 Pole

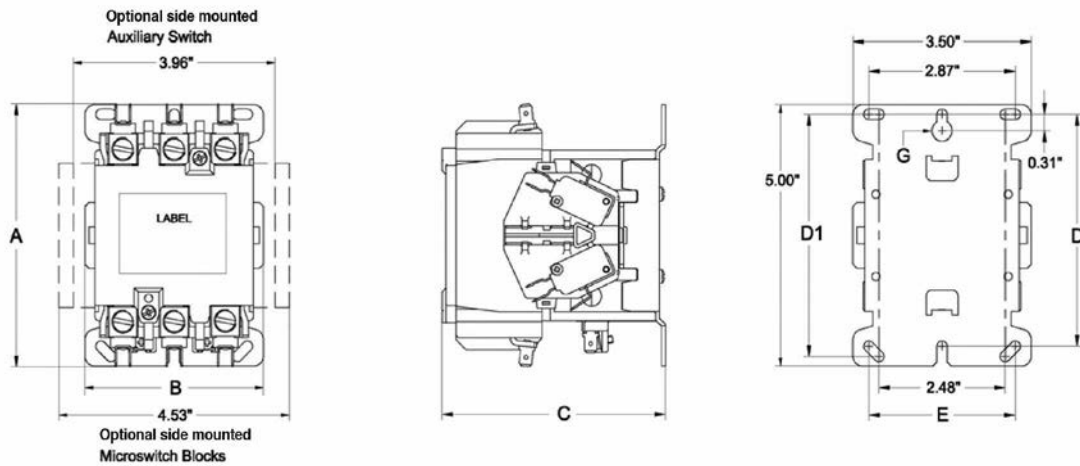

MARS NO.	FLA	POLES	A	B	C	D	D1	E	MTG SCREW G	MAX WIRE SIZE
61460-61464 61470-61474	50-60	3	4.04	2.87	3.11	3.13	3.25	2.24	10	2
61480-61484 61490-61494	75-90	3	5.02	3.5	4.39	4.43	4.63	2.87	10	1/10

# MARS 780 Definite Purpose Contactors

## Renewal Parts and Accessories

- Snap on side mounted auxiliary switches
- Replacement coils

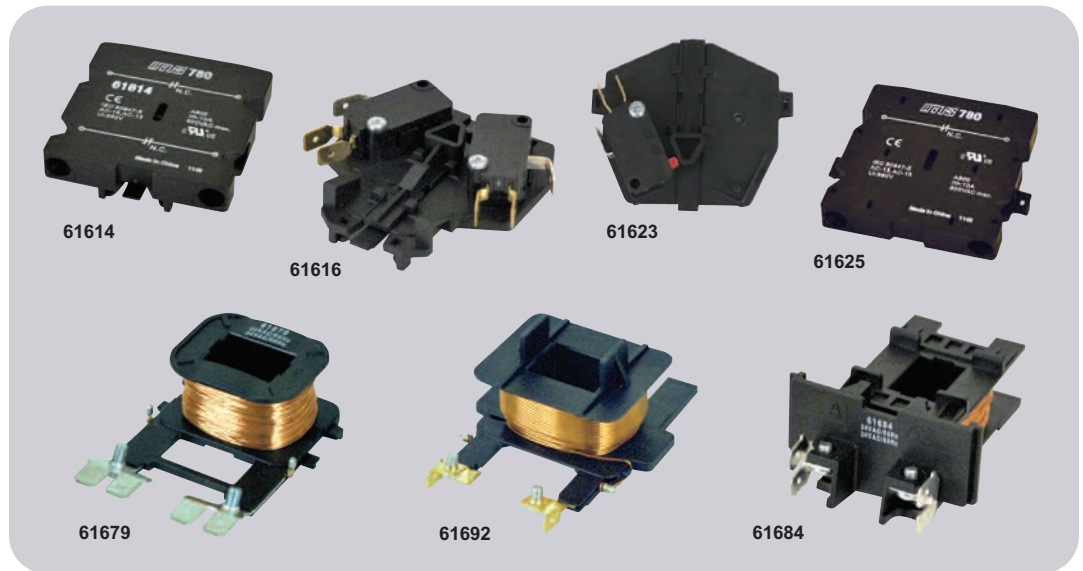

### Auxiliary Switches

MARS NO.	FURNAS NO.	DESCRIPTION	CONTACTOR F.L.A.	USED ON		
61610	49ACRO	1 NO	30 - 60	61320-61324 61720-61724 61730-61734 61345-61349 61745-61749 61755-61759 61430-61434 61750-61754 61445-61449 61425-61428 61440-61443 61460-61464 61470-61474		
61611	49ACRC	1 NC				
61612	49ACR6	1 NO- 1 NC				
61613	49ACR7	2 NO				
61614	49ACR8	2 NC				
61615	49D36098001	SPDT				
61616	49D36098003	DPDT				
61623	-	SPDT			75-90	61480-61484 61490-61494
61624	-	1 NO				
61625	-	1 NC				

### MARS 780 Replacement Coils

MARS NO.	FURNAS NO.	CONTACTOR SIZE	COIL VOLTAGE
61679	-	3 Pole 30-40 Amp	24V
61680	-		120V
61681	-		208-240V
61682	-		277V
61683	-	3 Pole 50-60 Amp	480V
61684	-		24V
61685	-		120V
61687	-		208-240V
61690	-		277V
61691	-		480V
61692	-	3 Pole 75-90 Amp	24V
61693	-		120V
61694	-		208-240V
61695	-		277V
61696	-		480V

### MARS 780 Contactor Coil Characteristics

Contactor Series	Inrush VA	Sealed VA	Sealed Watts
1 Pole with shunt 30 to 40 amp	40	7.5	2.5 - 3.5
2 Pole - Small Body 30- 40 Amp	45	8	2.5 - 4.0
2 Pole Large Body 30- 40 Amp	90	16	3.5 - 5.0
3 Pole 30 - 40 Amp	90	16	3.5 - 5.0
3 Pole 50 - 60 Amp	145	20	5.0- 7.0
3 Pole 75 - 90 Amp	235	32	10.0 - 12.0



## Furnas NEMA Contactors & Starters

### Application:

NEMA heavy duty contactors and starters are designed for across the line starting of 3 phase motors. Typical applications include cooling towers, refrigeration equipment, and commercial HVAC. NEMA contactors provide the switching (on/off) function. NEMA starters consist of a NEMA contactor with the addition of motor protection via a solid state overload relay which includes phase loss protection.

### Standard NEMA Contactor Features:

- Rugged industrial design epoxy encapsulated coil seals out moisture, promotes heat transfer, and resists electrical, mechanical, and thermal stresses. The 45 degree wedge action contacts reduce tracking and provide faster arc quenching. The resulting self-cleaning and reduced contact bounce mean cooler operation and longer life for the large silver cadmium oxide contacts
- Dual Voltage Coils  
120/240 VAC is standard  
24 VAC and 240/480 VAC are available as accessories
- Easy coil access. Top mounted coil requires no tools to change

### Standard NEMA Starter Features:

- NEMA Contactor
- True phase loss protection  
Trips within 3 seconds and is self protected from short circuits
- High accuracy +/- 2% repeat trip accuracy
- Self powered requires no hard wiring or separate power source
- Heaterless construction minimizes energy costs. Does not require the use of complicated heater charts. Simply set the dial on the overload relay to the motor F.L.A.
- Overload trip class 20

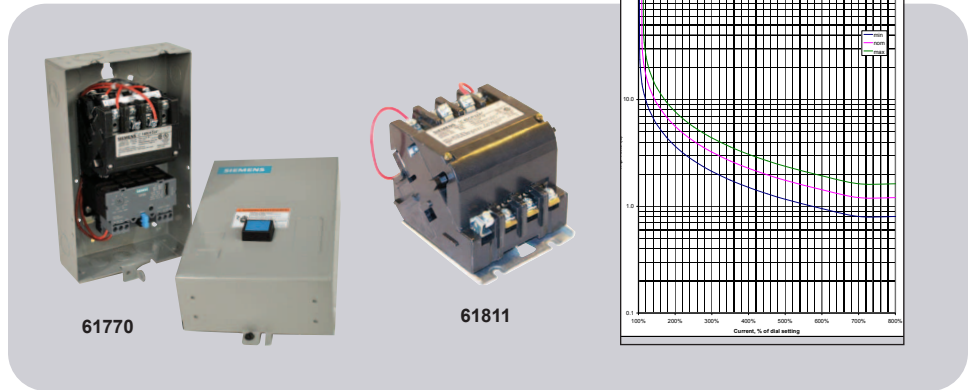

### NEMA Starters

MARS NO.	SEIMENS NO.	NEMA SIZE	AMP RATING	200V	HORSEPOWER 230V	460V	OVERLOAD RANGE	COIL VOLTAGE	ENCL.
61770	14CUC32BA	0	18	2	2	5	2.5-10A	120/240	NEMA 1
61771	14CUD32BA	0	18	3	3	-	9-18A	120/240	NEMA 1
61772	14DUC32BA	1	27	2	2	5	2.5-10A	120/240	NEMA 1
61774	14DUD32BA	1	27	3	3	10	9-18A	120/240	NEMA 1
61775	14DUE32AA	1	27	7-1/2	7-1/2	-	13-27A	120/240	Not Included
61776	14DUE32BA	1	27	7-1/2	7-1/2	-	13-27A	120/240	NEMA 1
61777	14ESG32BA	1-3/4	27	10	10	15	10-40A	120/240	NEMA 1
61779	14FUF32AA	2	45	-	-	15	13-52 A	120/240	Not Included
61780	14FUF32BA	2	45	10	15	25	22-45A	120/240	NEMA 1
61782	14HUG32BA	3	90	25	30	50	45-90A	120/240	NEMA 1
61783	14HUG32AA	3	90	25	30	50	45-90A	120/240	Not Included

### NEMA Contactors

MARS NO.	SEIMENS NO.	NEMA SIZE	AMP RATING	200V	HORSEPOWER 230V	460V	COIL VOLTAGE	ENCL.
61811	40DP32AA	1	27	7-1/2	7-1/2	10	120/240	Not Included
61813	40FP32AA	2	45	10	15	25	120/240	Not Included

### Parts & Accessories for Starters & Contactors

MARS NO.	SEIMENS NO.	DESCRIPTION	NEMA SIZE
61652	75D73070J	Coil 24VAC	0-2.5
61650	75D73070A	Coil 120/240V	0-2.5
61653	75D73070C	Coil 240/480V	0-2.5
61654	75D73070D	Coil 208V	0-2.5
61648	75D73251A	Replacement Coil 120/240V	3-3.5
61656	75CF14	Replacement Contact Kits*	0
61657	75DF14	Replacement Contact Kits*	1
61658	75FP14	Replacement Contact Kits*	2
61659	49AB10	N.O. Auxiliary Contact	0-3
61660	49AB01	N.C. Auxiliary Contact	0-3

\* Replacement contacts are sold in kits that will re-build 1 power pole. For example: Use (3) 75CF14 contact kits to re-build a 3 pole device.

# GE Definite Purpose Contactors

## Model 453 Definite Purpose Contactors

The compact models feature universal mount bases, taped coils, and combination phillips/ slot head screws. The GE compact design features "no burn" coil design. This self-protecting coil meets the Trane specification. 453 GE compact design contactor meets ARI 780. Some other manufacturer's economy model compact contactors do not meet this rigorous spec.

**Features:**

- Compact overall size
- Combo phillips/slothead screws/hexhead on 30 amp
- Universal mount base



**Specifications:**

**CR453C Compact, 30A, 40A, 1-Pole Plus Shunted Pole & 2-Pole**

FULL LOAD AMPS	RESISTIVE AMPS PER POLE	LOCKED ROTOR AMPS SINGLE PHASE, 50/60 HZ			POLES
		240/277V	480V	600V	
30	40	180	150	120	1 + Shunt

\* Ratings shown are for 1-phase, 2-pole.

MARS NO.	FLA	RESISTIVE RATING PER POLE	POLES	VOLTAGE	GE MODEL	HEIGHT	DIM. WIDTH	DEPTH
13101	30	40	1-1/2	24	453CC3HAAAM	2-9/16	2	3-1/4

# Universal Enclosure

## Universal Contactor Enclosure

The MARS 92680 Universal Contactor enclosure will fit contactors from 20 to 40 amp. This enclosure will also fit the new smaller frame ACC533 and ACC633 contactors. Each enclosure comes with all the necessary mounting screws.

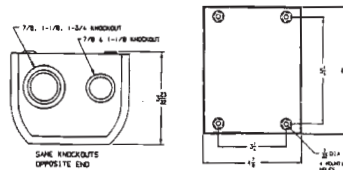

MARS NO.	MFG. PART NO.	DESCRIPTION
92680	AHK425A	Universal Contactor Enclosure

## MARS Definite Purpose Contactors

MARS definite purpose contactors are designed for use on refrigeration, air conditioning, and electric heating systems. They are available in one pole with shunt (one and one half pole) configurations, from 30 thru 40 amps. MARS brand definite purpose contactors are also available in 2 pole models (30 and 40 amp) and 3 pole models (30 through 75 amp). The universal mounting base allows replacement of most contactor brands. Straight-thru wiring and small size speeds installation.

### Features:

- Used in air conditioning, heating and refrigeration
- Box lug terminations speed installation
- Universal mounting base
- Contact cover and enclosed coils reduce dirt and insect intrusion
- Compact design
- Silver-Cadmium contacts

### Specifications:

- Meets ARI 780/790 requirements
- cULus Approval
- 1,000,000 Cycle mechanical life

### Auxiliary Switches

MARS NO	DESCRIPTION	USED ON
61623	SPDT	All 3 Pole 910
61624	1 NO	
61625	1 NC	

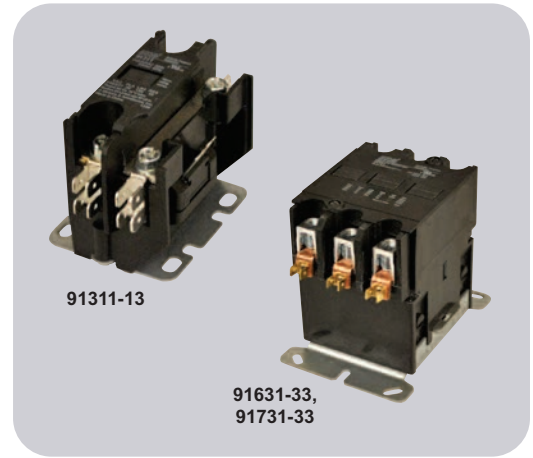

MARS NO.	FLA	POLES	LOCKED ROTOR AMPS				RES. AMPS	COIL VOLTS	TERMINATION	HORSEPOWER			
			240	277	480	600				1 PH	3 PH		
										240	240	480	600
91311	30	1 Pole w/Shunt	180	180			40	24	Screw Type	-	-	-	-
120													
208/230													
91315	30	1 Pole w/Shunt	180	180			40	24	Box Lug	-	-	-	-
120													
208/230													
91321	30	2	180	-	150	120	40	24	Screw Type	-	-	-	-
120													
208/230													
91325	30	2	180	-	150	120	40	24	Box Lug	-	-	-	-
120													
208/230													
91331	30	3	180	-	150	120	40	24	Screw Type	3 HP	7.5 HP	10 HP	15 HP
120													
208/230													
91335	30	3	180	-	150	120	40	24	Box Lug	3 HP	7.5 HP	10 HP	15 HP
120													
208/230													
91411	40	1 Pole w/Shunt	240	240	-	-	50	24	Box Lug	-	-	-	-
91421	40	2	240	-	200	160	50	24	Box Lug	-	-	-	-
120													
208/230													
91431	40	3	240	-	200	160	50	24	Box Lug	5 HP	10HP	15 HP	20 HP
120													
208/230													
91531	50	3	300	-	250	200	63	24	Box Lug	5 HP	15 HP	20 HP	25 HP
120													
208/230													
91631	60	3	360	-	300	240	75	24	Box Lug	7.5 HP	20 HP	25 HP	30 HP
120													
208/230													
91731	75	3	450	-	375	300	94	24	Box Lug	15 HP	25 HP	40 HP	40 HP
120													
208/230													

# Magnetic Line Contactors

## 30 Amp Two Pole Contactors

The MARS Series 180 contactors are designed primarily to replace contactors used in air conditioning and electric heating to control blower motors. In addition they are used to switch pumps and computer power supplies. Replace General Electric Contactors and other manufacturers including WR, Essex/RBM and Honeywell.

**Features:**

- Replace all 3ARR8, 9, 27, and 28 General Electric contactors
- Replace WR, Essex/RBM and Honeywell
- Instructions and cross reference chart included
- Non-positional
- UL and CSA listings available

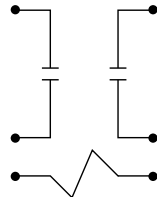

COIL schematic

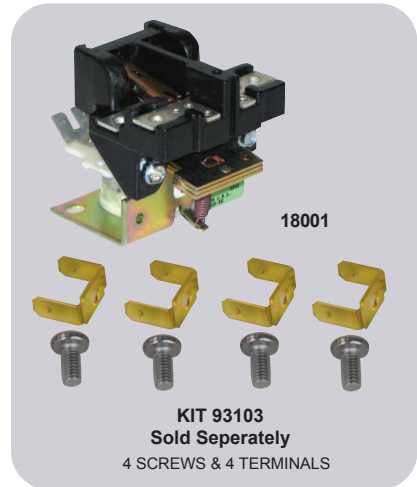

**KIT 93103**  
Sold Separately  
4 SCREWS & 4 TERMINALS

**Cross Reference**

Carrier	GE	Packard	Supco	Honeywell No.	Mars Replacement
HN52KC051	3ARR8E4	C18001	SMC11	R850B1146	18001

MARS NO.	DESCRIPTION	FULL LOAD AMPS	RESISTIVE AMPS	LOCKED ROTOR AMPS	COIL VOLTAGE	POLES	COIL VOLT	PICK-UP HOT	MAX COLD
18001	30 Amp 2 Pole Magnetic Line Contactor	30	30	120	24	2	24	20.5	19.2
93103	Push-On Terminals Adapters and Screws.	-	-	-	-	-	-	-	-

## Fan Centers

### MARS Relay/Transformer Fan Control Centers

MARS series 240 fan centers provide convenient low voltage control of one and two speed fan motors and auxiliary circuits in heating, cooling, or heating applications. Each MARS fan center is a reliable, compact unit consisting of a

**Schematic:**

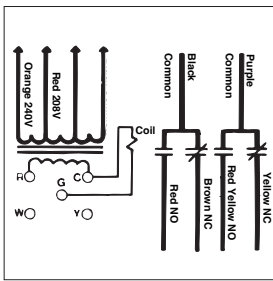

24010

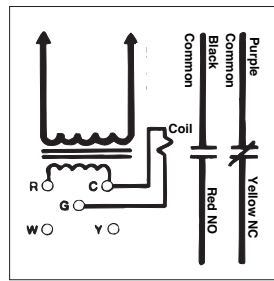

24012

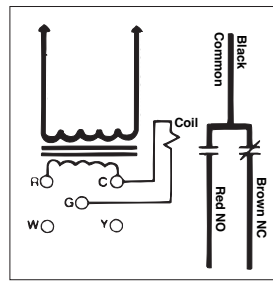

24013

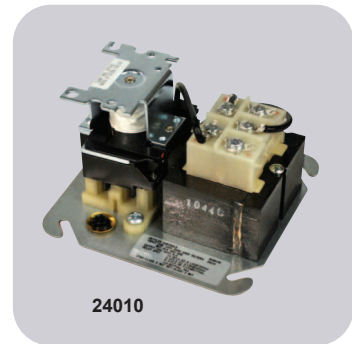

24010

24 volt control transformer and a plug-in switching relay mounted on a 4" square electrical junction box cover. All line voltage connections are made inside the box with color coded pre-stripped leads. Low voltage connections are made at a convenient terminal board mounted to the transformer.

**Features:**

- Choice of SPDT, SPNO / SPNC or DPDT relay switching options
- UL 1585 40VA transformer
- Color coded leads
- Low voltage terminal board
- Mounts directly to 4" electrical box
- 50/60 Hertz

**40VA 3/4 HP**

MARS NO.	TRANSFORMER		RELAY	CONTACT RATINGS			
	PRIMARY VOLTAGE	SECONDARY VOLTAGE		120V AC (AMPS)		240V AC (AMPS)	
				FULL LOAD	LOCKED ROTOR	FULL LOAD	LOCKED ROTOR
24010	120/208/240	24V	DPDT	13.8	82.8	6.9	41.4
24012	120	24V	SPNO/SPNC	13.8	82.8	6.9	41.4
24013	120	24V	SPDT	13.8	82.8	6.9	41.4

### MARS Control Transformers NEMA Class II Open Construction

MARS compact open construction transformers are less than 2-1/4" in height. This makes them ideal as replacements within existing equipment.

MARS control transformers are available with various outputs and voltages for special applications.

**Application:**

Provide power source for control circuit for air conditioning, heating, or refrigeration systems.

**Features:**

- UL class 2 recognized
- Low heat rise
- Primary color coded leads
- Secondary color coded leads, or 1/4" male quick connects
- Foot-mount



### Foot-Mount Open Construction

MARS NO.	VA RATING	HZ	PRIMARY		SECONDARY	
			VOLTAGE	CONNECTIONS	VOLTAGE	CONNECTIONS
50351	20	50/60	120	Color coded leads	24	Color coded leads
50352	40	50/60	120	Color coded leads	24	Color coded leads
50353	40	50/60	208/240	Color coded leads	24	Color coded leads
50354	40	50/60	120/208/240	Color coded leads	24	Color coded leads
50355*	40	60	120	Color coded leads	12/24	Color coded leads
50350	20	50/60	120/208/240	Color coded leads	24	Color coded leads
50357	40	50/60	277	Color coded leads	24	Color coded leads
50359 <sup>(1)</sup>	40	50/60	120/208/240	Color coded leads	24/12/2.5	Color coded leads

\* Not UL listed (1) In line fuse protection

### Foot-Mount Open Construction With Primary & Secondary Quick Connects

MARS NO.	VA RATING	HZ	PRIMARY		SECONDARY	
			VOLTAGE	CONNECTIONS	VOLTAGE	CONNECTIONS
50362	40	50/60	120	1/4" Male quick connects	24	1/4" Male quick connects
50364	40	50/60	120/208/240	1/4" Male quick connects	24	1/4" Male quick connects
50363	40	50/60	208/240	1/4" Male quick connects	24	1/4" Male quick connects

### MARS Control Transformers NEMA Class II End Bell Type

MARS end bell transformers provide enclosures for the primary and secondary windings, MARS multi-mount models offer three mounting options - Foot, Plate, or Conduit mount.

MARS control transformers are available with various outputs and voltages for special applications.

**Application:**

Provide power source for control circuit for air conditioning, heating, or refrigeration systems.

**Features:**

- UL class 2 recognized
- Low heat rise
- Primary color coded leads
- Secondary color coded leads, or screw terminals
- Multi-mount or plate-mount

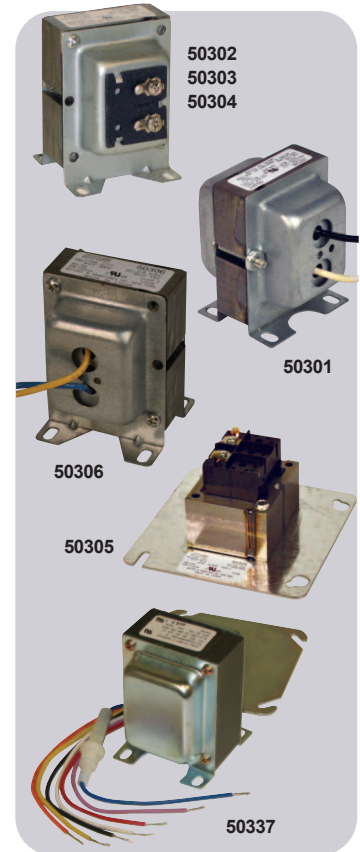

### Foot-Mount End Bell Type

MARS NO.	VA RATING	HZ	PRIMARY		SECONDARY	
			VOLTAGE	CONNECTIONS	VOLTAGE	CONNECTIONS
50301	20	60	120	Color coded leads	24	Color coded leads

### Multi-Mount End Bell Type

MARS NO.	VA RATING	HZ	PRIMARY		SECONDARY	
			VOLTAGE	CONNECTIONS	VOLTAGE	CONNECTIONS
50302	40	50/60	120	Color coded leads	24	Screw terminals
50303	40	50/60	208/240	Color coded leads	24	Screw terminals
50304	40	60	120/208/240	Color coded leads	24	Screw terminals
50306*	48	60	277	Color coded leads	24	Color coded leads
50314	50	50/60	120/208/240	Color coded leads	24	Color coded leads
50333*	48	50/60	120/208/240	Color coded leads	24/12/2.5	Color coded leads

\* Not UL listed (1) Color coded leads on secondary, (2) Screw terminals on secondary

### Plate-Mount End Bell Type

MARS NO.	VA RATING	HZ	PRIMARY		SECONDARY	
			VOLTAGE	CONNECTIONS	VOLTAGE	CONNECTIONS
50305	40	50/60	120	Color coded leads	24	Screw terminals

# Transformers

## MARS Control Transformers NEMA Class II

Hub-Mounted Transformers with Circuit Breakers and Multiple Inputs of 120/208/240/480 VAC

Available either in 50VA or 75VA, these 2 versatile transformers replace Honeywell® AT150F and AT175F. All leads pass through the chase nipple.

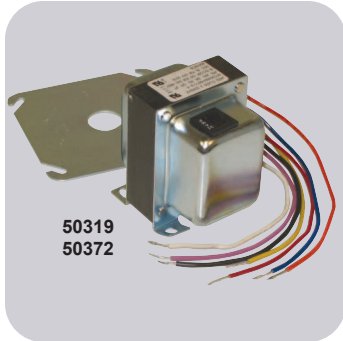

- MARS 50319, 50VA, MARS 50372, 75VA
- 3 Way mounting
- Four inputs including 120/208/240/480 VAC
- UL Recognized

### Hub Mount End Bell Type

MARS NO.	VA RATING	HZ	PRIMARY		SECONDARY	
			VOLTAGE	CONNECTIONS	VOLTAGE	CONNECTIONS
50319	50	50/60	120/208/240/480	Color coded leads	24	Color coded leads
50372	75	50/60	120/208/240/480	Color coded leads	24	Color coded leads

## MARS Control Transformers NEMA Class II Heavy Duty End Bell Type

MARS control transformers are available with various outputs and voltages for special applications.

### Application:

MARS heavy duty end bell transformers offer a wide variety of higher VA rated models. These models are the choice when extra power is the solution.

### Features:

- UL class 2 recognized
- 50/60 Hz
- Low heat rise
- Color coded leads
- Foot-mount



### Foot-Mount End Bell Type

MARS NO.	VA RATING	HZ	PRIMARY		SECONDARY	
			VOLTAGE	CONNECTIONS	VOLTAGE	CONNECTIONS
50316	60	50/60	208/240	Color coded leads	24	Color coded leads
50320 <sup>(1)</sup>	75	50/60	120/208/240/480	Color coded leads	24	Color coded leads
50326	75	50/60	480	Color coded leads	24	Color coded leads
50340*	100	50/60	120/208/240/480	Color coded leads	24	Color coded leads

\*100 VA does not qualify for NEMA Class II  
(1) Inline fuse

### Foot Mounted Open Construction

MARS NO.	VA RATING	HZ	PRIMARY		SECONDARY	
			VOLTAGE	CONNECTIONS	VOLTAGE	CONNECTIONS
50339 <sup>(2)</sup>	75	50/60	480	Color coded leads	120	Color coded leads

(2) UL 506

## MARS Control Transformers NEMA Class II Manual Reset Style

MARS control transformers are available with various outputs and voltages for special applications.

### Application:

Provide power source for control circuit for air conditioning, heating, or refrigeration systems.

### Features:

- UL class 2 recognized
- Low heat rise
- Color coded leads or quick connect terminals
- Foot-mount

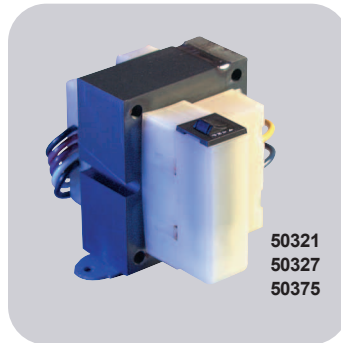

50321  
50327  
50375

## Foot-Mount End Bell Type with Manual Reset

MARS NO.	VA RATING	HZ	PRIMARY		SECONDARY	
			VOLTAGE	CONNECTIONS	VOLTAGE	CONNECTIONS
50327	50	60	120/208/240/480	Color coded leads	24	Color coded leads
50321	75	50/60	120/208/240/480	Color coded leads	24	Color coded leads
50375	75	50/60	120/208/240/575	Color coded leads	24	Color coded leads
50341*	100	50/60	120/208/240/480	Color coded leads	24	Color coded leads
50312	60	50/60	120/208/240/480	Color coded leads	24	Color coded leads
50370	75	50/60	120/277/380/575	Color coded leads	24	Color coded leads
50371	100	50/60	120/208/277/575	Color coded leads	24	Color coded leads

\* 100VA and higher does not qualify for NEMA Class II

## MARS Power Transformers

### Application:

Provide 120V power source for air conditioning, heating, or refrigeration systems. MARS power transformers provide dual purpose options — 120V or 24V secondary with 208V/240V/480V primary connections. Three VA selections offer a true powerhouse!

### Features:

- Color coded leads
- Compact size
- Low heat rise



50380

## Power Transformers Foot-Mount Open Construction

MARS NO.	VA RATING	HZ	PRIMARY		SECONDARY	
			VOLTAGE	CONNECTIONS	VOLTAGE	CONNECTIONS
50380 <sup>(1)</sup>	50	60	208/240/480	Color coded leads	120/24	Color coded leads
50381 <sup>(2)</sup>	100	60	208/240/480	Color coded leads	120/24	Color coded leads

(1) Not UL listed

(2) UL 506

## GE Type Ip Core and Coil Transformers

GE type IP transformers are core and coil units designed for industrial control, panel board, HVAC and general purpose applications. They conform to ANSI C89.2, and are UL listed and CSA certified. These transformers are lightweight, small and designed for minimum mounting dimensions.



50502

### Features:

- 60 Hz
- Encapsulated thru 500VA
- Control power applications
- UL listed, UL-506 File E2739
- CSA certified, C22.2 Number 66, File 3272
- 50 Hz available on special order basis

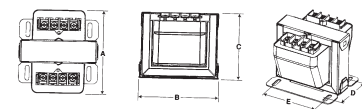

top view

front view

Encapsulated Style Views

## Encapsulated

MARS NO.	CONT. KVA	PRIMARY	SECONDARY	DIMENSIONS				
				A	B	C	D	E
50502	.075	240/480	120/240	4.22	3.29	2.79	2.41	2.50
50504	.150	240/480	120/240	4.67	4.04	3.29	2.66	3.12
50506	.250	240/480	120/240	5.17	4.04	3.29	3.16	3.12
50507	.300	240/480	120/240	5.17	4.04	3.29	3.16	3.12

## JARD Transformers

### Hub-Mounted Transformers with Circuit Breakers and Multiple Inputs of 120/208/240/480 VAC



Available either in 50VA or 75 VA, these 2 versatile transformers replace Honeywell® AT150F and AT175F. All leads pass through the chase nipple.

- Model 5041MCB, 50 VA, Model 7541MCB, 75 VA
- Plate mount or foot mount
- Four inputs including 120/208/240/480 VAC
- UL Recognized

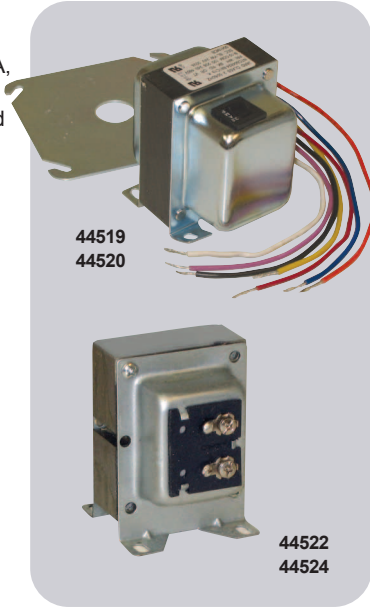

MARS NO.	JARD NO.	VA	PRIMARY VAC	SECONDARY VAC
44519	5041MCB	50	120/208/240/480	24
44520	7541MCB	75	120/208/240/480	24

### Multi-Mount Transformers Closed Construction, 4" x 4" Plate

- Optional 3-way mounting for maximum flexibility
- Safety agency approved
- Welded laminations for quiet operation

MARS NO.	JARD NO.	VA	PRIMARY VAC	SECONDARY VAC
44522	4011M	40	120	24
44524	4031M	40	120/208/240	24
44525	5031M	50	120/208/240	24
44526	5032M	48	120/208/240	2.5/12/24

### Fully Enclosed Junction Box Ready



- Several models with dual voltage output
- Welded laminations for quiet operation
- Conservative heat rise characteristics
- UL 506

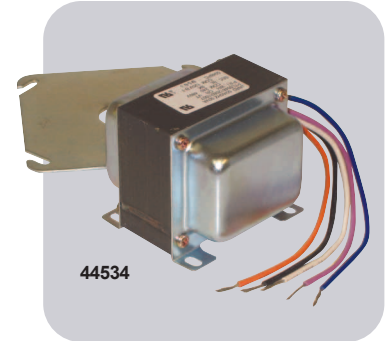

MARS NO.	JARD NO.	VA	PRIMARY VAC	SECONDARY VAC
44533	5048STPC	50	208/277/575	120
44534	10048PC	100	240/480	120
44535	10048STPC	100	208/277/575	120



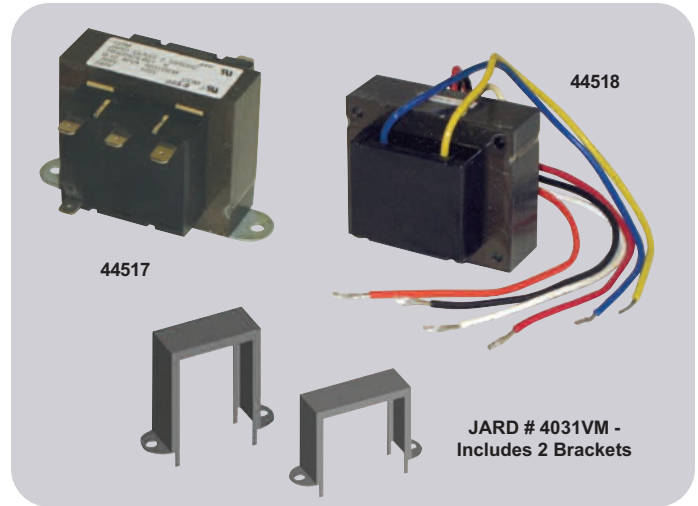
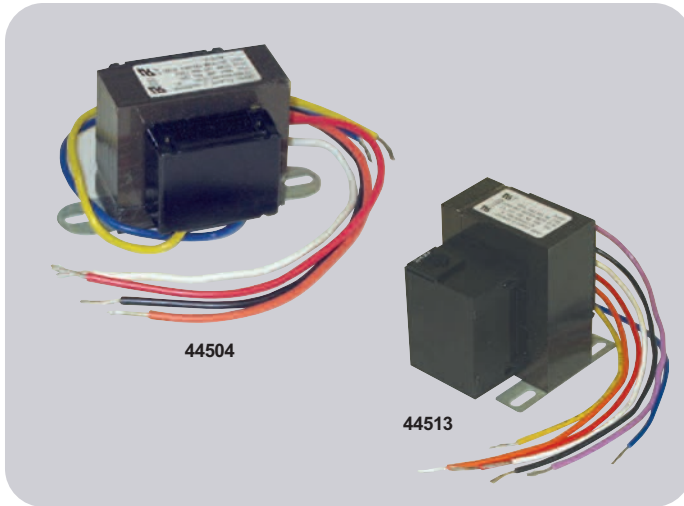

### Open Construction, Wire Leads

- Safety agency approved

MARS NO.	JARD NO.	VA	PRIMARY VAC	SECONDARY VAC
44501	2031F	20	120/208/240	24
44502	4011F	40	120	24
44503	4021F	40	208/240	24
44504	4031F	40	120/208/240	24
44505	4032F	40	120/208/240	2.5/12/24
44507	40271F	40	277	24
44508	5031F	50	120/208/240	24
44509	5032F	50	120/208/240	2.5/12/24
44510	7531F	75	120/208/240	24

### Closed Construction Quick Connect

MARS NO.	JARD NO.	VA	PRIMARY VAC	SECONDARY VAC
44517	4031OEM	40	120/208/240	24

### Versatile 3-Way Mounting

MARS NO.	JARD NO.	VA	PRIMARY VAC	SECONDARY VAC
44518	4031VM	40	120/208/240	24

### Closed Construction With Circuit Breaker

- All models feature a UL recognized manual reset circuit breaker
- Safety agency approved

MARS NO.	JARD NO.	VA	PRIMARY VAC	SECONDARY VAC
44511	5041C	50	120/208/240/480	24
44512	6041C	60	120/208/240/480	24
44513	7541C	75	120/208/240/480	24
44514	7541STC	75	120/277/380/575	24
44515 <sup>(1)</sup>	10041C	100	120/208/240/480	24

(1) Not UL, UL506

# MARS Surge Protection Device

## MARS Side Open Disconnect Boxes with Internal Surge

MARS Disconnect with integrated surge protector provides a unitized design for quick and clean installation. The metal weather-resistant enclosure provides additional robustness and security. MARS Surge Protectors provide the performance necessary to protect critical components in high efficiency mini-split and unitary HVAC equipment.

**Features:**

- Side open disconnect
- Integrated internal surge protector
- Thermally Protected MOV's
- Metal-weather resistant enclosure
- External - Green & Red LED Status Indicators
- 3 Year Warranty
- \$7,500 Connected Equipment Warranty

**Specifications Disconnect:**

- Single phase 240V
- 10,000 Amp rating
- NEMA 3R enclosure
- Weather proof enclosure
- Available in fused and non-fused

**No. 83910 Surge Protector:**

- 120/240V Single (Split) Phase 50/60Hz
- Short Circuit Current Rating
  - 22,000 Amps
- MCOV L-G 150V / L-L 300V
- Voltage Protection Rating
  - L-G 700V / L-L 1200V
- UL 1449 4th Edition
- Type 1 or 2 Surge Protection Rating

**Protects:**

- Compressors
- Heat Pumps
- Ideal for Ductless System
- Inverter Boards
- ECM Motors
- Control Boards
- Transformers
- Relays
- Sensors

MARS NO.	DESCRIPTION	ENCLOSURE	INCLUDES SURGE PROTECTOR
83915	60 Amp Non-Fused w/Surge Module	NEMA 3R, Rainproof	MARS NO. 83910
83916	30 Amp Fused w/Surge Module	NEMA 3R, Rainproof	MARS NO. 83910
83917	60 Amp Fused w/Surge Module	NEMA 3R, Rainproof	MARS NO. 83910

MARS NO.	DESCRIPTION
83910	Replacement Surge Module For 83915, 83916 and 83917



## MARS HVAC Surge Protective Device

The MARS SPD is designed to protect your HVAC equipment from power spikes, surges and transients. Power spikes and surges can damage compressors, control boards, sensors and ECM motors resulting in costly repairs and down time. The MARS SPD utilizes Thermally Protected MOV technology to provide safe and reliable surge protection.

**Protects:**

- Compressors
- Heat Pumps
- Ideal for Ductless Systems
- Inverter Boards
- ECM Motors
- Control Boards
- Transformers
- Relays
- Sensors

**Features:**

- Easy Installation to Disconnect
- Weatherproof 4X Enclosure
- 18" Pre-stripped Leads
- Green & Red LED Status Indicators
- Thermally Protected MOVs
- 120/240V Single (Split) Phase 50/60Hz
- Short Circuit Current Rating
  - 22,000 Amps
- MCOV L-G 150V / L-L 300V
- Voltage Protection Rating
  - L-G 700V / L-L 1200V
- UL 1449 4th Edition
- Type 1 or 2 Surge Protection Rating
- 3 Year Warranty
- \$7,500 Connected Equipment Warranty

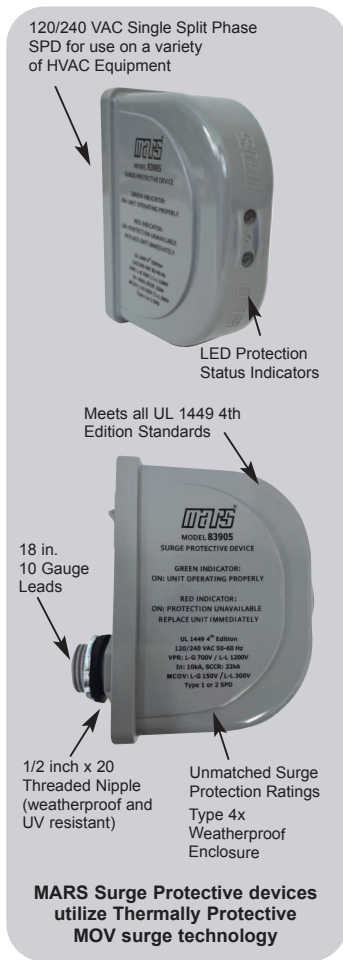

MARS Surge Protective devices utilize Thermally Protective MOV surge technology

MARS NO.	VOLTAGE	WIRE CONFIGURATION	SPD TYPE	MCOV	ENCLOSURE	UL 1449 4TH EDITION
83905	120/240	L-L, L-G	1 or 2	150/300	Type 4X	cULus

## MARS HVAC Surge Protective Device

The MARS 83904 SPD is designed specifically for 120V furnace and air handler applications. The furnace and air handler contain components that must be protected from surges such as, ECM motors, Control Boards, Transformers. The MARS Surge utilizes thermally protected MOV technology for safe and reliable protection of equipment. The 120V Surge Device is easy to install with only 2 wires to connect.

**Protects:**

- Ideal for 120V Ductless Systems
- Furnace & Air Handlers
- Inverter Boards
- ECM Motors
- Control Boards
- Transformers
- Relays
- Sensors

**Features:**

- Easy 2 Wire Installation
- 10" Pre-stripped Leads
- Green LED Status Indicator
- Thermally Protected MOVs
- 120V Single Phase 50/60Hz
- Short Circuit Current Rating
  - 10,000 Amps
- MCOV L-G 150V
- Voltage Protection Rating
  - L-G 700V
- UL 1449 4th Edition
- Type 1 or 2 Surge Protection Rating
- 3 Year Warranty
- \$7,500 Connected Equipment Warranty



MARS Surge Protective devices utilize Thermally Protective MOV surge technology

MARS NO.	VOLTAGE	WIRE CONFIGURATION	SPD TYPE	MCOV	ENCLOSURE	UL 1449 4TH EDITION
83904	120	L-G	1 or 2	150	Type 2	cULus

## MARS HVAC Surge Protective Device

The **iSPD** (*Intelligent Surge Protection Device*) offers comprehensive protection for your HVAC equipment.

The MARS 83907 Surge Protection Device is designed to provide maximum compressor protection from harmful power surges, transients and over-voltages utilizing the latest Thermally Protected MOV technology.

In addition, the modules microprocessor technology monitors line voltage to protect the compressor from starting or running during "brown outs" and low line voltage. The module also monitors refrigerant temperatures to identify coil freeze-up and low refrigerant issues.

If the module detects a low voltage or refrigerant issue the compressor is shut down. The module will automatically reset when specified operating parameters are restored and determined to be stable.

In the event of diminished surge protection or failure, the compressor will not be allowed to start until the module is replaced.

### Protects the Following Equipment and Components:

- Compressors
- Control & Defrost Boards
- Sensors & Relays
- Transformers
- Heat Pumps
- Reversing Valves
- ECM Motors

### Plus:

- Low Voltage Protection
- Coil Freeze-up / Low Refrigerant Detection
- Short Cycle Guard

### Features:

- Easy installation to disconnect box
- Weatherproof 4X enclosure
- Fits 1/2" knockouts
- Green & Red LED status indicators
- Thermally protected MOV's
- 240V single phase 50/60Hz
- Max surge current 10,000 A
- Max continuous over voltage
  - L-G 150V / L-L 300V
- Voltage protection rating
  - L-G 700V / L-L 1200V
- 3 Year warranty
- \$7,500 Connected equipment warranty

MARS NO.	VOLTAGE	WIRE CONFIGURATION	SPD TYPE	MCOV	ENCLOSURE	UL 1449 4TH EDITION
83907	240	L-L, L-G	1 or 2	150/300	Type 4X	cULus

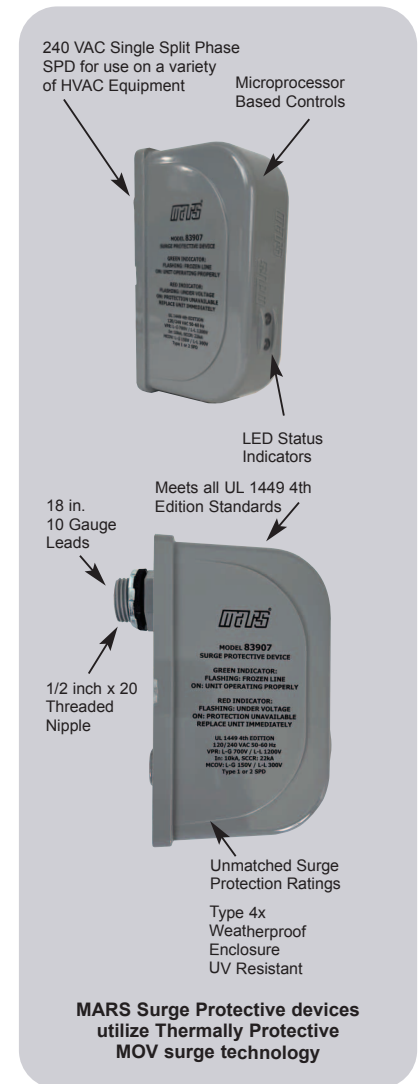

# Condensate Pumps

## MARS Condensate Pump - 24' Lift

MARS new line of medium condensate pumps are designed to out-perform the competition while providing quiet operation and reliability.

The MARS pump design couples industry leading performance with the installation flexibility and features you need to get the job done.

The quick release silicone check valve allows for quick and efficient servicing without the need to remove the condensate line.

The integrated safety switch can be wired for equipment shut down or directly to a high level alarm.

**Features:**

- 24 foot lift
- 125 gph
- 0.5 gal reservoir
- Patent pending, quick release check valve
- Field serviceable "duck bill" check valve
- Rubber isolation feet
- Drip proof housing design
- Solid float
- Integrated safety switch 250 volt and float switches
- ABS and stainless steel construction



21780

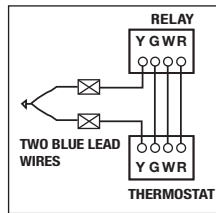

MARS NO.	DESCRIPTION
21780	115 V, 60 Hz, 0.91 Amps, 71 Watts 6' Cord, 3/8" Check Valve, Safety Switch Medium Reservoir
21781	115 V, 60 Hz, 0.91 Amps, 71 Watts 6' Cord, 3/8" Check Valve, Safety Switch 20' Tubing, Medium Reservoir
21782	230 V, 60 Hz, 0.6 Amps, 75 Watts 6' Cord, 3/8" Check Valve, Safety Switch Medium Reservoir
21783	230 V, 60 Hz, 0.6 Amps, 75 Watts 6' Cord, 3/8" Check Valve, Safety Switch 20' Tubing, Medium Reservoir

### Gallons Per Hour Pump Performance Comparison Chart

FOOT LIFT	1	5	10	15	20	24
MARS	125	98	74	70	43	7
Comp. 1	84	75	60	42	10	0
Comp. 2	117	98	70	58	11	0
Comp. 3	105	95	73	36	0	0

### Specifications: Performance-Gallons Per Hour @ Height In Feet

MODEL NO.	1	5	10	15	20	24
21780	125	98	74	70	43	7
21781	125	98	74	70	43	7
21782	139	119	70	50	28	7
21783	139	119	70	50	28	7

### Check Valve Replacement

MARS NO.	DESCRIPTION
21787	Check Valve Replacement Kit



21787

## MARS Low Profile 22' Pump

**Features:**

- Low profile pump
- Compact design
- Integrated safety switch
- Quick service check valve
- Drip proof housing
- Class leading performance



21784

MARS NO.	DESCRIPTION
21784	115 V, 60 Hz, 1.07 Amps, 67 Watts, Low Profile, 22' Lift 6' Cord, 3/8" Check Valve, Safety Switch Medium Reservoir
21785	230 V, 60 Hz, 0.53 Amps, 68 Watts, Low Profile, 22' Lift 6' Cord, 3/8" Check Valve, Safety Switch Medium Reservoir

## MARS 16' Pump

**Features:**

- 16' lift pump
- Whisper quiet
- 1/2 gal reservoir
- Rubber isolation feet
- Quick service check valve
- Class leading performance



21786

MARS NO.	DESCRIPTION
21786	115 V, 60 Hz, 0.75 Amps, 49 Watts, 16' Lift 6' Cord, 3/8" Check Valve, Safety Switch Medium Reservoir

MODEL NO.	DIMENSIONS		
	LENGTH	WIDTH	HEIGHT
21780	10.25	5.125	6.375
21781	10.25	5.125	6.375
21782	10.25	5.125	6.375
21783	10.25	5.125	6.375
21784	10.25	5.04	5.28
21785	10.25	5.04	5.28
21786	10.25	5.125	6.375

### Condensate Pump vs. Competition

FEATURE	MARS	COMP. 1	COMP. 2	COMP. 3
24 ft. Lift	●			
Motor Corrosion Protection	●			
Drip Proof Motor Housing	●	●		●
Drip Proof Motor & Switches	●			
Vibration Absorbing Rubber Feet	●	●	●	
Side Mount	●	●	●	●
Quick Release Check Valve	●	●		
Internal Safety Switch	●		●	
Solid Float	●	●		●

### MARS AllStart™ Hard Start Device

The MARS AllStart™ is a two wire hard start device designed to provide maximum starting torque for single phase PSC and CSIR compressors up through 10HP. The MARS AllStart™ recycles instantly for maximum convenience on troublesome hard start jobs.

Independent testing has determined that the MARS AllStart™ provides more starting torque than other competitive models, and this results in quicker starts. Test results on a range of head pressures from 166 to 300 PSI indicate that the MARS AllStart™ started the test compressor in an average of 21.7% less time than the leading competitor! More available starting torque means less time to get problem compressors started.

MARS offers the largest assortment of refrigeration and air conditioning compressor starting components. When the proper starting relay and capacitor combination is a must, they are available from MARS. When getting a problem compressor started in the field "NOW" is the job, rely on the new MARS AllStart.™



**Features:**

- Maximum starting torque!
- More than 20% faster starts!
- Easy two wire installation
- Recycles instantly
- Individually packaged with wiring instructions

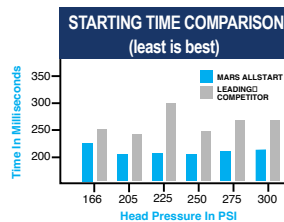

**Cross Reference**

KickStart/ RectorSeal	Parts Connect	Ranco	Supco	MARS Replacement
T05	PSA8	RSPP8E	SPP8E	32708

MARS NO.	MODEL NO.	H.P.	VOLT MAX.
32708	AllStart	1/2 to 10	115-277V

### MARS Combination Starters

The MCS is a combination start relay, start capacitor, and motor overload. It is designed to replace those components on a 115 volt single phase refrigeration compressor installed on a capillary tube system.

The MCS is factory wired and comes with a connection diagram on the product label for maximum convenience.



**Features:**

- Maximum starting torque!
- More than 20% faster starts!
- Easy two wire installation
- Recycles instantly
- Individually packaged with wiring instructions

**Cross Reference**

Parts Connect	Ranco	Supco	MARS Replacement
PCS410	RSO410	RCO410	32741
PCS810	RSO810	RCO810	32781

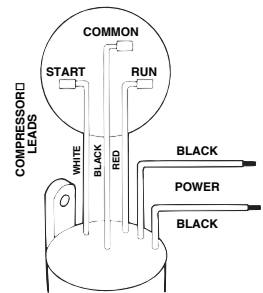

MARS NO.	MODEL NO.	H.P.	VOLT MAX.
32741	MCS 41	1/4 TO 1/3	115V
32781	MCS 81	1/12 to 1/5	115V

### MARS Motor Torque Multiplier

The MARS MTX 100, MTX 200 motor torque multipliers feature a combination PTC solid state device, and start capacitor in one compact unit.

The MTX 100 is designed for use on PSC motors and compressors up to 5HP, 277V maximum; the MTX 200 is designed for use on PSC motors and compressors up to 10HP, 277V. These units are easily installed by connecting the two leads from the MTX unit to the motor run capacitor terminals.

**Features:**

- Totally solid state integrated design
- Fast, easy two wire installation
- Three mounting options; clip, screw, or capacitor bracket
- Individually packaged

**Cross Reference**

5-2-1/CPS Products	Diversitech	Parts Connect	Ranco	Supco	MARS Replacement
CSRU1	DST-5	PSA5	RSPP5	SPP5	32701
-	DST-6	PSA6	RSPP6	SPP6	32702



MARS NO.	MODEL NO.	H.P.	VOLT MAX.
32701	100	1/2 to 5	277V
32702	200	1/2 to 10	277V

# MARS Start Assists

## MARS 3 Wire Hard Start Kits

MARS 3 Wire Hard Start Kits provide the additional starting torque required for quicker compressor starts in systems using higher pressure refrigerants. Improved starting performance extends compressor life and minimizes potential refrigerant contamination due to overheated compressor windings. MARS Hard Start Kits also improve system life and performance by reducing undue overload stress on contactors and run capacitors.

If your system is slow to start, MARS has a Hard Start Kit to fit your application.

### Features:

- Start relay made in the USA and approved by all compressor manufacturers.
- Start capacitor made in Mexico
- 30% faster starts
- 3 wire design ensures proper "drop-out"
- Extends life of compressor
- Kit contains mounting hardware

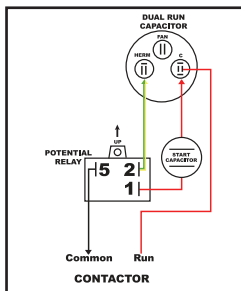
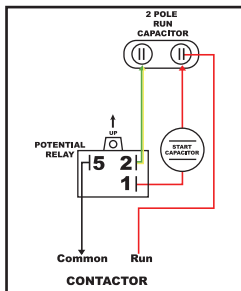

### Cross Reference

MARS NO.	5-2-1 (CPS)	Supco	Packard (2 wire)	Diversitech (2 wire)
32715	CSR U1	3W1	TQS1	HSK5
32716	CSR U2	3W2	TQS2	HSK1
32717	CSR U3	3W3	-	-

MARS NO.	VOLTS	DESCRIPTION
32715	208-230/240	3 Wire Hard Start 1 to 3 Ton
32716	208-230/240	3 Wire Hard Start 3.5 to 5 Ton
32717	208-230/240	3 Wire Hard Start 4 to 5 Ton

## MARS 2 Wire Hard Start Kits

MARS 2 Wire Hard Start Kits provide quick and easy installation on the job-site with only 2 connections. 2 Wire Hard Starts provide the additional starting torque for quicker compressor starts and improves compressor. MARS Hard Start kits also improve system life and performance by reducing undue overload stress on contactors and run capacitors.

If your system is slow to start, MARS has a Hard Start Kit to fit your application.

### Features:

- Start relay made in the USA and approved by all compressor manufacturers.
- NGM Start Capacitor is approved by all major HVAC manufacturers
- 30% faster starts
- Extends life of compressor
- 2 wire design speeds installation
- Kit contains mounting hardware

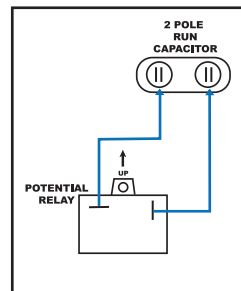
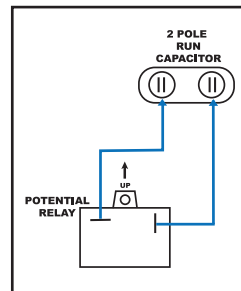

### Cross Reference

MARS NO.	KickStart	Packard (2 wire)	Diversitech (2 wire)
32713	TO-5	TQS1	HSK5
32714	KS-1	TQS2	HSK1

MARS NO.	VOLTS	DESCRIPTION
32713	208-230/240	2 Wire Hard Start 1 to 3 Ton
32714	208-230/240	2 Wire Hard Start 3.5 to 5 Ton

# MARS General Purpose Switching Relays

## For Motor Starting Circuits up to One Horsepower

### Features:

- Replace Potter & Brumfield PR series, Deltrol, Guardian, Magnacraft, etc.
- Plastic enclosed coil minimizes damage, resists dirt and moisture
- 5/16" diameter silver contacts for long life
- Tough phenolic base
- Reinforced screw terminals
- UL and CSA listings available



MARS NO.	P & B SERIES	CONTACTS ARRANGEMENT	AMP	COIL VOLTAGE	COIL RES. IN OHMS	NOM. POWER
43008	PRD7AY0	DPST-NO	25	120	290	9.8VA
43014	PRD11AY0	DPDT	25	120	290	9.8VA

### Cross Reference Information

POTTER & BRUMFIELD	MARS NO.	DETROL NO.	MARS NO.
PR7AY0-120V	43008	20240-83D	43008
PR11AY0-120V	43014	20241-83D	43014

## Replacement Relay for Fan Control Centers

Provides quick and easy plug-in installation to restore like new operation without replacing the entire fan center. The universal relay will cover all MARS fan centers and many competitive brands.

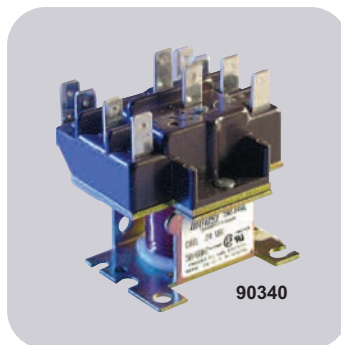

MARS NO.	USED ON	DESCRIPTION
90340	24010, 24012, 24013	DPDT universal plug-in replacement relay

## 2-Pole Air Conditioning Relays

The MARS Series 903 switching relays are intended for many applications in air conditioning, refrigeration, and heating. Other uses include general purpose switching in appliances, fan controls, and vending machines. Our relays are available in 24, 110/120, and 208/240 coil voltages with various combinations of power and pilot duty contacts.

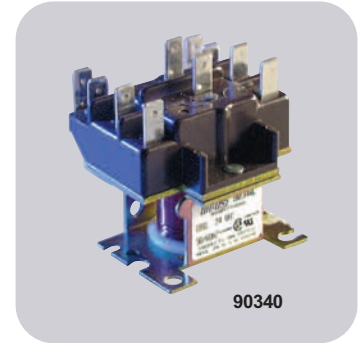

### Features:

- Replaces Honeywell and White-Rodgers/RBM - cross reference on package
- Double quick-connect terminals on coil
- 2.13 x 1.88 x 2.25 in.
- Base is designed for easy replacement of competitive relays
- Molded terminal numbers and circuit diagram on top of relay
- UL and CSA listings available

	POWER		PILOT	
	120V	208/240V	120V	208/240V
Full Load Amps	12	6	-	-
Resistive Amps*	15	15	3	3
Locked Rotor Amps	60	35	-	-
Horsepower	3/4	3/4	1/10	1/10

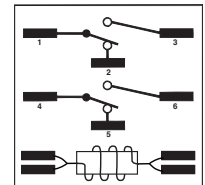

\*277 VAC

MARS NO.	COIL VOLTAGE	TERMINALS 1-2-3	TERMINALS 4-5-6
90340	24		
90341	110/120	Power	Power
90342	208/240		
90343	24		
90344	110/120	Power	Pilot
90345	208/240		
90346	24	Pilot	Pilot
90348	208/240		

### Cross Reference Information

WR/RBM NO.	MARS REPLACEMENT	HONEYWELL NO.	MARS REPLACEMENT
90-340	90340	R4222B1082	90344
90-341	90341	R4222B1090	90345
90-342	90342	R4222D1013	90341
90-343	90343	R4222D1021	90342
90-344	90344	R4222N1010	90348
90-345	90345	R4222V1002	90344
90-346	90346	R4222V1010	90345
90-348	90348	R8222B1067	90343
		R4222D1014	90340
		R8222N1011	90346
		R8222V1003	90343

# MARS General Purpose Switching Relays

## SPST and SPDT Fan Relays

The MARS Series 903 relays are among the most popular relays used in air conditioning today. They will replace the WR/Essex/RBM Type 84 (90-290 thru 90-295) quick-connect and screw terminal versions.

**Features:**

- 0.25 inch quick-connect terminals
- Packaged with instructions and cross reference
- Replace 90-290 thru 90-295 and 90-290Q thru 90-295Q
- Dimensions: 2.38 x 1.63 x 1.50 in.
- Tab bracket, Non-positional
- UL and CSA listings available



COIL VOLTAGE	MARS NO. SPST	MARS NO. SPDT
24	90290	90293
110/120	90291	90294
208/240	90292	90295

**Contact Rating—  
All Models/Amps**

VOLTAGE	FULL LOAD	LOCKED ROTOR	RESISTIVE
120	12	60	18
240	8	48	18
277	7	42	18

**Cross Reference Information**

WR/RBM NO.	MARS NO.	WR/RBM NO.	MARS NO.
90-290	90290	90-293	90293
90-290Q	90290	90-293Q	90293
90-291	90291	90-294	90294
90-291Q	90291	90-294Q	90294
90-292	90292	90-295	90295
90-292Q	90292	90-295Q	90295

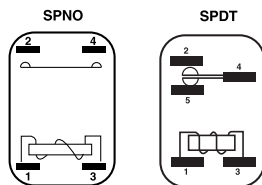

Coil Data:  
24-240 VAC @ 50/60 Hz;  
5 VA Max. Inrush; 3.0 VA Max. Sealed

## Heavy Duty Fan Relays

MARS Heavy Duty Fan Relays are used on heating and air conditioning equipment to provide switching of heavier loads with a compact size relay. MARS Heavy Duty Fan Relays replace WR/Essex/RBM type 184.



**Features:**

- 0.25 inch quick-connect terminals
- Packaged with instructions and cross reference
- Replaces WR/Essex/RBM Type 184
- Tab bracket, Non-positional
- UL and CSA listings available

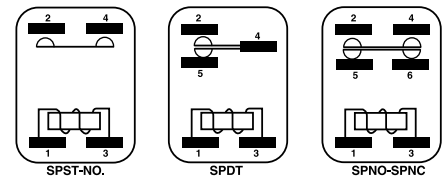

**Contact Rating—  
All Models/Amps**

VOLTAGE	FULL LOAD	LOCKED ROTOR	RESISTIVE
120	12	60	18
240	8	48	18
277	7	42	18

**Coil Data**

COIL VOLTAGE	MAX INRUSH	MAX SEALED
24	5 VA	3 VA
120	5 VA	3 VA
208/240	5 VA	3 VA

**Cross Reference**

COIL VOLTAGE	MARS NO. SPST	MARS NO. SPDT	MARS NO. SPNO-SPNC	WR/RBM NO.	MARS NO.	WR/RBM NO.	MARS NO.
24	90360	90370	90380	90-360	90-360	90-374	90374
110/120	90362	90372	90382	90-362	90-362	90-380	90380
208/240	90364	90374	90384	90-364	90-364	90-382	90382
277		90377		90-370	90-370	90-384	90384
				90-372	90-372		



## MARS Enclosed Switching Relays

MARS enclosed switching relays are heavy duty general purpose relays suitable for a variety of applications. They are commonly used in heating, air conditioning, vending machines, office machines, control panels and other general purpose applications. They are available in single pole, two pole and three pole models for either bracket or plug-in mounting. All MARS enclosed switching relays are protected by a tough polycarbonate cover to keep out dust and dirt. Blade type terminals fit standard plug-in mounts plus allow use with 3/16 inch quick-connect terminals or direct soldering.

### Features:

- Simple connections
- One, two and three pole models
- Plug-in or bracket mount
- See-through protective cover
- Three-way blade terminals, plug-in, quick-connect or solder
- UL and CSA listings available

### Specifications:

Dimensions: 2.0 X 1 1/2 X 1 3/8

Terminals: 3/16 blade

Coil Data: 2.0 VA

Contact Material: Silver alloy, gold flashed

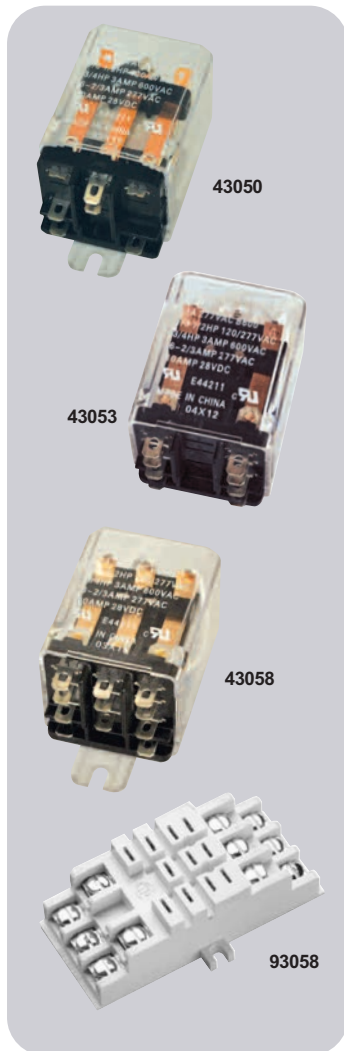

## MARS Current Relays - Universal Replacement

MARS current relays manufactured by General Electric can replace almost any current relay found on refrigerators, freezers, water cooler, pumps and vending machines.



### Features:

- Replace plug-on, bracket-type, split-phase, and capacitor-start current relays
- Covers replacement needs of 1/12 H.P. 115V to 1/8 H.P. 115V
- Clearly labeled terminals for fast wiring
- Each relay packaged with installation instructions and wiring diagrams
- UL and CSA listings available

MARS NO.	GE NO. 3ARR12 PAC	MAX PICK-UP	MIN DROP OUT	APPLICATION SURVEY BY HORSEPOWER1 (AT 115)2							
				1/12	1/8	1/6	1/5	1/4	1/3	1/2	3/4
27001	309A	3.8	3.2	■	□	□	□	□	□	□	□
27002	310A	5.2	4.4	□	■	□	□	□	□	□	□

1. Current relays cannot be replaced by horsepower, amperage, or nameplate data alone. Refer to cross reference information for proper replacement of original equipment current relays by part numbers.
2. These current relays are often used on 230 volt applications, however this horsepower survey refers only to 115 volt applications.

MARS NO.	COIL VOLTAGE	HZ	AMP RATING	HORSEPOWER		SWITCH ACTION	TYPE MOUNT
				120V	240V		
43050	24	50/60	13	1/3	1/2	SPDT	bracket
43053	24	50/60	13	1/3	1/2	DPDT	bracket
43054	120						
43056	24	50/60	13	1/3	1/2	3PDT	bracket
43057	120						
43058	240						
43063	24	50/60	13	1/3	1/2	DPDT	plug-in
43064	120						
43066	24						
43067	120	50/60	13	1/3	1/2	3PDT	plug-in
43068	240						
93058	Socket Base. Can be surface or DIN rail mounted.						

# MARS Relays & Potential Relays

## For Submersible Pump Applications

The MARS 550 and 551 relays were specifically developed for submersible pump and other motor starting applications in high moisture environments. Because the control panels for these are often located in areas of high humidity, the components on them must resist the effects of moisture. Chrome plating on the core and armature and the relatively small area of contact eliminates armature sticking due to organic contaminants which was the number one cause of relay failure.



19550

### Features:

- Used on F.E. Meyers, Franklin Electric, Jacuzzi, Red Jacket, Sta-Rite, and Tait
- 2 relays replace over 25 O.E.M. relays
- Universal break-off bracket on each relay. Simply snap off parts not needed
- UL and CSA listings available

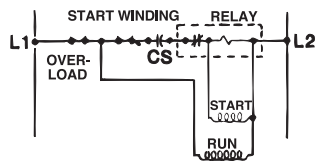

MARS NO.	MARS MODEL NO.	CONTINUOUS COIL VOLTAGE	PICK-UP		DROP-OUT	
			MIN.	MAX.	MIN.	MAX.
19550	MARS 550	130	111	134	15	40
19551	MARS 551	332	244	270	40	90

MARS NO.	G.E. NO.	USED BY
16104	3ARR3J3G3	Barnes [Burks, Decator] & Myers

MANUF.	OEM NO.	GE CAT. NO.	MARS NO.	MANUF.	OEM NO.	GE CAT. NO.	MARS NO.
F.E. Meyers	13178-A	3ARR3D7J4	19550	Jacuzzi	23-1308-26	3ARR3EA9V5	19551
	13179-A	3ARR3D3V4	19551		23-1308-00	3ARR3EA7J5	19550
	13180-A	3ARR3D3A4	19551		23-1308-18	3ARR3EA7BB5	19550
	17891-A	3ARR3EA3A4	19551		23-1308-34	3ARR3EA5U5	19551
	17890-A	3ARR3EA3V4	19551		23-1308-42	3ARR3EA7M5	19550
Franklin Electric	17889-A	3ARR3EA7J4	19550	Red Jacket	23-1308-49	3ARR3EA5C5	19551
	155031-101	3ARR3J7J4	19550		71-69	3ARR3EA7M5	19550
	155031-102	3ARR3J9V4	19551		71-70	3ARR3EA5B5	19551
	155031-104	3ARR3J2P3	19550		71-47	3ARR3J3V2	19551
	155031-103	3ARR3J9U4	19551		U18-325	3ARR3J3V3	19551
Sta-Rite	155031-105	3ARR3J7M1	19550	U18-665	3ARR3J3A3	19551	
	Tait	U18-810	3ARR3J2P3	19550	U18-810	3ARR3J2P3	19550
		U18-811	3ARR3J5V3	19551	U18-811	3ARR3J5V3	19551
		A124P2	3ARR3EA5A5	19551	A124P2	3ARR3EA5A5	19551
		A124P1	3ARR3EA7K5	19550	A124P1	3ARR3EA7K5	19550

## One-On-One™ Direct Replacement Potential Relays

The relays are exact replacements for Bristol & Copeland applications. They conform to specifications and in most cases are the one-on-one™ replacement relay used by the manufacturer

Other relays available on special order. Contact your local wholesaler or MARS Customer Service.



16028

BRISTOL	MARS	COPELAND	COPELAND	MARS
650058	16028	MARS	040-0001-64	16098
650855	16051		040-0001-68	16099
			040-0001-71	16116
		040-0001-48	16093	16122
BRISTOL	MARS	040-0001-50	16085	16121
650971	16083	040-0001-53	16095	16152
		040-0001-54	16089	
COPELAND	MARS	040-0001-55	16023	
040-0001-00	16086	040-0001-59	16090	
040-0001-01	16093	040-0001-60	16091	
040-0001-04	16085	040-0001-61	16086	
040-0001-12	16098	040-0001-62	16035	
040-0001-17	16095			
040-0001-19	16089			
040-0001-20	16023			
040-0001-25	16035			
040-0001-26	16022			
		COPELAND	MARS	
		040-0001-88	16151	
		040-0001-89	16155	

## Universal Replacement

### Quick Reference Relay Selection Chart For General Electric Relays

1. Determine the General Electric model number of the Relay to be replaced the "FORM" and "GROUP"

EXAMPLE:	1 or 2 Letters		1 or 2 Letters	
	Basic Type	FORM	GROUP	Non-Positional
3ARR3*	A	3B	3	

### Cross Reference Information

WR/RBM NO.	MARS NO.	WR/RBM NO.	MARS NO.
90-1	19002	90-25	19006
90-2	19009	90-26	19008
90-3	19004	90-27	19005
90-4	19003	90-40	19004
90-5	19006	90-41	19008
90-6	19006	90-63	19002
90-7	19004	90-64	19003
90-8	19003	90-65	19004
90-9	19007	90-66	19005
90-10	19008	90-67	19006
90-11	19003	90-68	19007
90-12	19007	90-69	19001
90-13	19005		
90-14	19003		
90-15	19006		
90-16	19007	TECUM. NO.	MARS NO.
90-17	19002	82777	19002
90-18	19008	82778	19004
90-19	19006	82779	19008
90-20	19007	82781	19010
90-21	19002	82783	19003
90-22	19003	82784	19009
90-23	19007	82785	19006
90-24	19008	82787	19007

2. Locate in the following table the Relay GROUP and select the corresponding MARS Replacement Relay from the kit.

19002	MARS 63 replaces Relay GROUPS 2J; 2K; 2L; 2M; 5N; 7J; 7K; 7L; 7M; 7N; 8L; 8M; 8N
19003	MARS 64 replaces Relay GROUPS 3A; 3B; 3AV; 3AU; 4A; 4B; 6A; 6B; 6AV; 10A; 10B; 10AU; 10AV
19004	MARS 65 replaces Relay GROUPS 3P; 3R; 3AP; 5P; 5R; 5S; 5T; 22S
19005	MARS 66 replaces Relay GROUPS 3U; 3V; 3AT; 6U; 6V; 6W
19006	MARS 67 replaces Relay GROUPS 3C; 3D; 3AA; 4C; 4D; 4BK; 6C; 6D; 6AA; 10C; 10D; 26A; 26B; 26C; 26D
19007	MARS 68 replaces Relay GROUPS 3E; 3F; 3AB; 3AC; 4E; 4F; 4G; 6E; 6F; 6G; 10H; 10AB; 10AC; 26E; 26F; 26G; 26H; 27E; 27F; 27G
19008	MARS 69 replaces Relay GROUPS 3S; 3T; 10S; 10T; 25S; 25T; 10AS
19009	MARS 70 replaces Relay GROUPS 5B; 5C; 5D; 5AA; 8B; 8C; 8D
19010	MARS 71 replaces Relay GROUPS 6TV; 6TW; 10V

3. Install relay in accordance with instructions in MARS Replacement Kit

## MARS Universal Replacement

The MARS refrigeration potential relay service kit has become an industry standard since its introduction over fifty years ago. Its long-term reliability and easy replacement have been the key to its success. The wide calibration ranges and the universal bracket make the MARS potential relay is a must on every service truck.

### Features:

- Genuine MARS relays replace thousands of O.E.M. models
- Non-positional
- Wide range of selectivity
- QC-6 Kit included with each relay to convert screw-on to push-on
- Instructions and wiring diagram included in each relay
- Universal break-off bracket on each relay. Simply snap-off parts not needed
- UL and CSA listings available

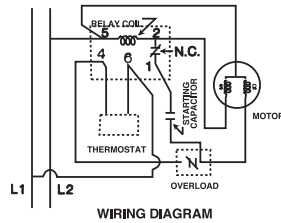
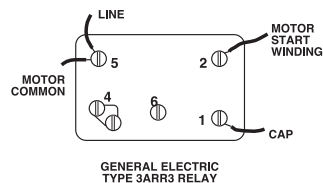

## Calibration Specifications

MARS NO.	MARS MODEL NO.	CONTINUOUS COIL VOLTAGE	PICK-UP		DROP-OUT MAX
			MIN.	MAX	
19002	MARS 63	170	139	153	55
19003	MARS 64	395	260	275	120
19004	MARS 65	332	168	182	90
19005	MARS 66	395	215	225	120
19006	MARS 67	420	295	315	125
19007	MARS 68	502	325	345	135
19008	MARS 69	336	180	195	105
19009	MARS 70	253	285	305	77
19010	MARS 71	420	212	232	121
93001	QC-6	—	—	—	—

## MARS HVAC Potential Relays

MARS series relays are manufactured for the HVAC industry. These relays meet all requirements for original equipment relays.

### Features:

- 50/60 Hz
- cULus
- Contact rating 35 amp, 400 VAC
- Operating position tab up
- Instructions and wiring diagram included in each relay
- Class "B" insulation

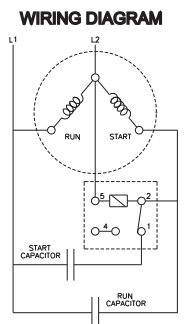
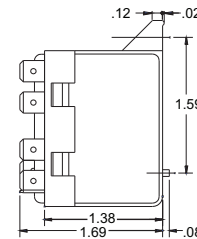
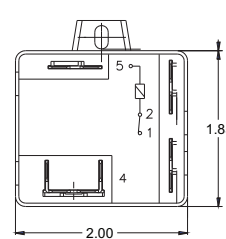
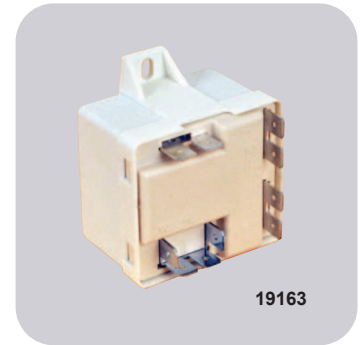

## Calibration Specifications

MARS NO.	MARS MODEL NO	CONTINUOUS COIL VOLTAGE	PICK-UP VOLTAGE	DROP-OUT VOLTAGE
19163	MARS 163	168	140-153	20-45
19164	MARS 164	420	242-272	60-121
19165	MARS 165	332	171-184	40-90
19166	MARS 166	420	204-233	60-121
19167	MARS 167	420	300-328	60-121
19168	MARS 168	502	314-342	60-135
19169	MARS 169	332	180-193	40-90
19170	MARS 170	253	285-305	35-77
19171	MARS 171	420	204-233	60-121

Note: If used on 50 Hz, the PU will be about 13% lower

# Leak Detectors

## MARS H-10 Pro Universal Refrigerant Leak Detector

The MARS H-10 Pro combines and enhances all the features of the previous H-10 Series models into one full featured unit. The H-10 Pro Refrigerant Leak Detector continues to be the universal standard for checking halogen-based refrigerant leaks in residential and commercial applications. With automatic auto zero balance control it's unique sensor calibration system will pinpoint small, medium and large leaks. The instrument uses a tried-and-true positive ion emission heated diode with audible and visual leak rate indicators. It is the most sensitive and accurate leak detector to detect all CFC, HFC and HCFC refrigerants as low as 0.006 oz/yr, including R-410A and R-507. The unit is mounted in a durable carry case which houses the 4.5 foot probe with built in filter, carrying strap, wall adapter and operating instructions.



### Features:

- All CFC, HFC and HCFC refrigerants, including but not limited to: R-12, R-22, R-134a, R-404A, R-410A, R-502, R-507, HFO-1233zd, HFO-1234yf and HFO-1234ze
- Not to be used with any refrigerant classified as Hardly Flammable (A2L and B2L), Flammable (A2 or B2), or Highly Flammable (A2 or B3)
- Improved sensor responsiveness with ultra-sensitive detection
- Dual power sources include rechargeable battery or external DC powered (wall adapter included)
- Selectable sensitivity to pinpoint small, medium or large leaks
- Unique visual sensor calibration system (with included reference leak bottle)
- Rugged enclosure with shoulder strap included
- Manual or automatic zero modes
- Headphone port allows for optional headset use in high-noise environments

### Specifications:

**Nominal Leak Range:** 0.006 oz/yr (stationary) | 0.1 oz/yr (moving probe per SAE J2791)

**Power Supply:** 12 VDC - internal rechargeable sealed lead acid battery; 100-240 VAC wall adapter/universal battery charger to charge or run continuously

**Reference Leak:** Approx. 0.006 oz/yr (stationary) | 0.1 oz/yr (moving probe per SAE J2791), 1 year life (typical)

**Ambient Operating Temp:** 32°F to 104°F (0°C to 40°C)

**Battery Life:** 3 hours (typically)

**Warm Up Time:** Approx. 2 min.

**Response Time:** 1 second

**Gases Detected:** All CFC, HFC and HCFC non-flammable refrigerants

**Detection Principle:** Positive Ion Emission Heated Diode

**Probe Length:** 4.5 feet

**Dimensions:** 10.5" L x 8.3" W x 5.4" H

**NOTE:** sensors are consumed in normal operation. It is good practice to have a spare sensor available at all times.

MARS NO.	CATALOG NO.	DESCRIPTION
25301	H-10 Pro	Universal Refrigerant Leak Detector, Wall adapter or Battery Powered

## Renewal Parts

MARS stocks genuine renewal parts for MARS, GE, and Bacharach H-10 Series Leak Detectors.



## Renewal Parts For H-10 Professional, H-10N, H-10G, and H-10B

MARS NO.	CATALOG NO.	DESCRIPTION	H-10 PRO/PM	H-10N	H-10G	H-10B
25310	M1101UD	Maintenance kit (100 filters, 3 rubber probe tips)	✓	✓	✓	✓
25315	H10N04	Plug-in sensor element	✓	✓	✓	✓
25314	M1101UU	Probe tip - clear plastic	✓	✓	✓	✓
25309	E7076DX	Rubber tip for probe	✓	✓	✓	
25325	M1101AH	Battery charger - 120-240 VAC	✓			
25323	M1101UC	Super tune up kit; sensor, leak vial, 100 filters 3 flow balls and 3 rubber probe tips	✓	✓	✓	✓
25326	M1101AD	Battery for H-10 Pro	✓			
25321	K9344AH	Reference Leak Assembly	✓	✓	✓	✓

## MARS Solid State Motor Starting Relay for Refrigerators and Freezers

MARS 32330 is a solid state PTC motor starting relay that mounts directly to any 3-pin fuse connector. One model replaces thousands of current relays used on 1/12 HP to 1/3 HP compressors.

### Features:

- Replaces Tecumseh Relays SSR2 and SSR3 for push-on applications.
- Non-positional
- One model for 1/12 HP to 1/3 HP, 120 volt
- UL and CSA listings available

MARS NO.	HORSEPOWER	VOLTAGE
32330	1/12 - 1/3	120

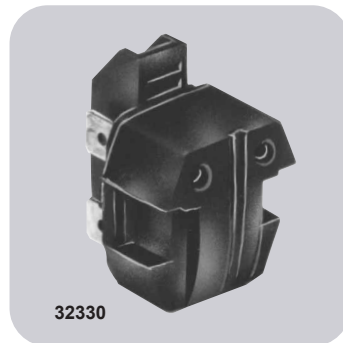
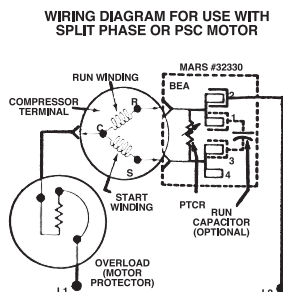

## MARS Solid State Timers Delay On Make

The MARS 32391 is the top-selling timer in the industry. Its reliability has been proven in the field by knowledgeable contractors.

The MARS 32391 will not be fooled by the thermostat anticipator.

Heavy duty MARS timers are offered for higher current applications.



### Features:

- Easy two-wire installation
- Proven reliability, all solid state
- .25 in. quick connect terminals
- Mounts in any position
- Compact size
- High accuracy
- Totally enclosed and encapsulated for proper heat dissipation

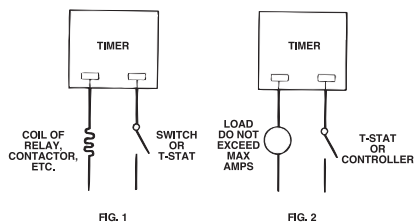

### Specifications:

- .040 amps min. latch current

MARS NO.	TYPE DELAY	TIME DELAY RANGE	TYPE OF ADJUSTMENT	INPUT VOLTAGE	HZ	MAX AMPS.	VOLTAGE DROP	CONN. DIA.
32391	on make	6 sec...8 min.	dial	19...240VAC	50/60	1	2.5 at 1 amp.	1

## Mars Solid State Timers Delay On Break

MARS solid state delay on break timers are designed to prevent short cycling of air conditioning, refrigeration and heat pump compressors. Upon application of power the load is energized. When the thermostat opens, or if there is a momentary loss of power, the load is de-energized and the delay period begins. The compressor will not start again during the delay period.

MARS number 32392 is a versatile two wire timer that features adjustable timing and can be used with any voltage from 19 thru 240 VAC, 50 or 60 Hz.

The MARS 32505 are the most simple and economic ways to stop short cycling on 24 VAC controlled systems. Both devices are fixed 5 minute delay on break timers.



### Features:

- 1 to 3 second random re-start
- Dial adjustable
- Compact size
- Mounts in any position
- .25 in. quick connect terminals
- Proven reliability
- MARS delay-on-break timers are not load sensitive

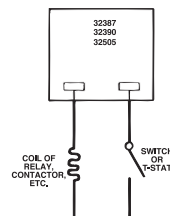

### Adjustable

MARS NO.	TYPE DELAY	TIME DELAY RANGE	TYPE OF ADJUSTMENT	INPUT VOLTAGE	HZ	MAX AMPS.	VOLTAGE DROP
32392	on break	6 sec...5 min.	dial	19...240VAC	50/60	1	2.5 at 1 amp.

### Fixed Delay

32505	on break	5 min.	none	20-30 VAC	50/60	1	3 at 1 amp.
-------	----------	--------	------	-----------	-------	---	-------------

# MARS Solid State Timers & Devices

## Fan Time Delay Module

The MAHBC fan time delay module is a replacement for the direct motor control used by leading OEMs in high efficiency residential central air conditioning systems. The purpose of the control is to keep the blower motor running for 60 seconds after the thermostat has been satisfied. The result is an increase in residual cooling from the indoor coil without running the condensing unit, and thus, higher energy efficiency. The MAHBC is ideal for retrofit where improved efficiency is desirable.

**Features:**

- Wide ambient temperature operating range -40°F to 175°F
- 1/4" male quick connect terminals
- Easy surface mount with four #6 screws
- UL and CSA recognized

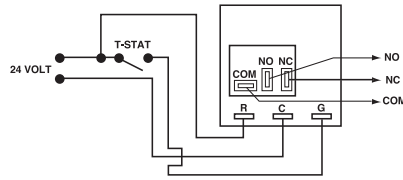
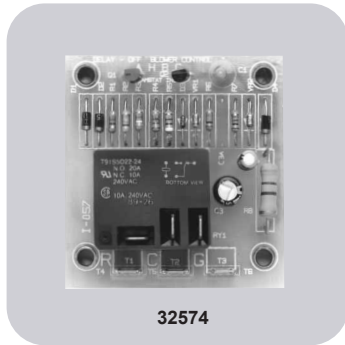

**Cross Reference**

OEM	PART NO.
BARD	8201-056
RHEEM	42-22515-01
SNYDER GENERAL	0001395336

MARS NO.	MARS MODEL	VOLTAGE	OUTPUT		TIME DELAY	ACTION
			120V	240V		
32574	MAHBC	24VAC	1 HP	2 HP	60 SEC.	SPDT

## MARS Bypass Timer

MARS 32395 is an adjustable, multi-voltage bypass timer that allows the temporary bypass of a control or device during start-up. At the end of the delay period the control is returned to the circuit.

Eliminate nuisance trips!

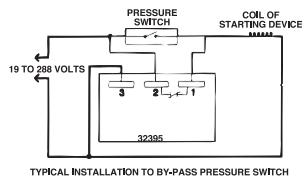

Low pressure switch bypass application.

FIGURE 1  
LOAD IS BYPASSED ON RETURNS TO CIRCUIT AFTER DELAY PERIOD.

MARS NO.	TYPE DELAY	TIME DELAY RANGE	TYPE OF ADJ.	INPUT VOLTAGE	HZ	MAX AMPS	VOLTAGE DROP	CONN. DIAGRAM
32395	by-pass	6 sec...8 min.	dial	19...240VAC	50/60	1	2 at 1 amp.	1

## Compressor Anti-Short Cycle Timer with Low Voltage Brownout Protection

Delay on break.

OEM replacement timers for Lennox, Rheem, Ruud, Trane, Heil Quaker, Keep Rite, Mc Quay, Snyder General and others.

**Features:**

- Lockout delay prevents rapid cycling compensated resistor type wall thermostats
- Single hole mounting (.25 inch diameter)
- Non-positional
- Brownout protection prevents startup when voltage is below normal conditions
- Reduces nuisance service calls due to short cycling
- Delay on Break Lockout delay starts with opening of thermostat or loss of power
- .25 in. quick-connect terminals
- Eliminates relay chatter due to thermostat bounce
- Small size 2.00 x 2.00 x .75 in.
- UL and CSA listings available



**Operation:**

On initial closure of the thermostat, the compressor relay energizes immediately. When the thermostat opens, a lockout condition and a time delay is initiated. During this lockout time delay period, the compressor cannot be energized. Brownout protection prevents energizing of the compressor when the line voltage is below normal conditions.

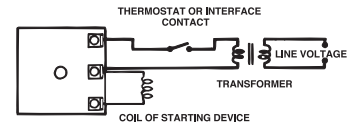

**With Integral Brownout Protection**

MARS NO.	MODEL NO.	OPERATING VOLTAGE (NOMINAL)	TIME DELAY (MIN.) ± 2%	MARS NO.
32382	TA24A5	24 VAC	5	1.5

### MARS Universal Replacements for Refrigeration and Air Conditioning

MARS motor protectors solve the serviceman's most annoying problem—finding suitable replacements for motor overload protectors.

**Features:**

- Used in refrigeration, room air conditioners, heating, appliances, and electric motors
- Each overload has six-inch leads and two wire nuts for simple installation
- UL and CSA listings available



### Application Survey By Horsepower\*

MARS NO.	HORSEPOWER																
	110/115								208/240V								
	1/20	1/12	1/8	1/6	1/5	1/4	1/3	1/2	1/12	1/8	1/6	1/5	1/4	1/3	1/2	1	
35010			■	■	■	■									■	■	
35011				■	■	■									■	■	
35012				■	■	■									■	■	
35014					■	■									■		
35015					■	■	■									■	
35016					■	■	■									■	
35017						■	■										■
35018						■	■	■									■
35019							■	■									

### 3/4" A/C Overloads

MARS NO.	TEMPERATURE CODE
35101	MRA-3763-529
35105	MRP-00-AIU-529

\*Motor protectors cannot be replaced by horsepower, amperage, or nameplate data alone. Refer to cross reference information for proper replacement of original equipment motor protectors by part number.

# Klixon 3-Phase Motor Protectors & Commercial Refrigeration Thermostats

## On-Winding Overheat Protection

Klixon SL-11 kits are mounted on the windings of general purpose motors and hermetically sealed compressors. They supplement conventional current overload relays in magnetic starters providing modern total protection for most older motors in use today.



### Features:

- Allow motors to perform at full-load capacity but will protect against dangerous running overloads
- Protect against blocked ventilation, high ambient temperatures, single phasing
- Each kit contains three matched motor-winding thermostats
- When starter overloads operate, the SL-11 will protect against re-starting at unsafe winding temperatures.
- These motor winding thermostats do not replace overloads in the starter
- UL & CSA listed

### Installation:

SL-11 thermostats are tied in place on the end turns of appropriate winding bundles, one to each phase or buried in the windings during motor rewind. They are connected in series between the starter coil and its power supply.

### Selection:

- Pick thermostat temperature to operate at the mid-point between the "maximum normal running" temperature and the "maximum allowed running temperature."
- Subtract the gradient temperature (outlined in the chart below) from the mid-point to obtain the operating temperature of the thermostat.

## Epoxy-Sealed Thermostats For General Purpose Motors - Normally Closed

MARS NO.	KLIXON KIT NO	KLIXON CAT. NO	OPERATING TEMPERATURE
37075	SL-11-75	9700K51-146	75°C
37100	SL-11-100	9700K26-146	100°C
37110	SL-11-110	9700K36-146	110°C
37120	SL-11-120	9700K01-146	120°C
37130	SL-11-130	9700K11-146	130°C
37135	SL-11-135	9700K06-146	135°C
37140	SL-11-140	9700K66-146	140°C
37145	SL-11-145	9700K76-146	145°C
37150	SL-11-150	9700K46-146	150°C

Three thermostats per package

Typical Gradients	Thermostat Location		Maximum Contact Rating Amps			
	Tied On End Turns	Buried In End Turns	Klixon #	24V	115V	230V
Open Type	30°C	15°C	9700K	18	18	12
Totally Enclosed						
Fan Cooled	25°C	10°C				
Totally Enclosed Non-Ventilated	20°C	5°C				

## Refrigeration Cases and Coils

MARS has selected the most popular Klixon disc-type thermostats found in commercial refrigeration. These controls cover a wide assortment of applications including supermarket cases and walk-in, reach-in, and beverage coolers.

### Features:

- Used on refrigeration cases, coils, with many other commercial applications
- Long lead wires supplied to satisfy most requirements
- Used by Hussman, Friedrich, Larkin, Schaefer, etc.
- 1 inch discs fully encapsulated for trouble-free use
- Mounts directly on coil tube or surface for maximum temperature response
- UL and CSA listings available
- 25 resistive amps maximum

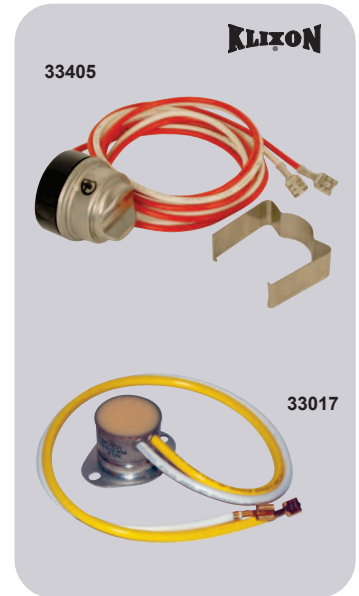

ELECTRICAL RATING			
		TERM. 1-3	TERM. 1-2
Full load amps	120V	13	5.8
	240V	10	2.9
Locked rotor amps	120V	60	34.8
	240V	45	17.4
Pilot Duty	120/240V	125	125
Resistive amps	120/240V	25	25
	277V	15	15

## Tube Mounting

MARS NO.	KLIXON NO.	O.E.M.	O.E.M. PART NO.	SWITCH ACTION	OPERATING TEMPERATURES F°		TUBE MT. IN	LEADS IN
					OPEN	CLOSE		
33405	20420D24-106-63	Bally	—	D	70	20	5/8	18
33415	20420D24-399-350		—	D	65	20	5/8	20
33420	20428F1-4-676	Friedrich	606-038-00	F	35	55	3/8	20
33425	20420L15-913-302		794-824-00	L	40	25	5/8	11
33430	20420D1-166-336		—	D	50	35	1/2	18
33435	20420L28-229-89	Hussman	P211-119696	L	20	5	3/4	40
33455	20420F19-63-294	Schaefer	C10872-19	F	20	60	5/8	36
33460	20420L19-202-274		C10872-6	L	35	5	5/8	54
33470	20420L15-376-218		125211	L	50	30	5/8	36
33475	20420L15-722-218	Tyler Ref.	146291	L	40	20	5/8	36
33480	20420L15-767-257		146739	L	80	50	5/8	90

## Surface Mounting

MARS NO.	KLIXON NO.	O.E.M.	O.E.M. PART NO.	SWITCH ACTION	OPERATING TEMPERATURES F°		LEADS IN
					OPEN	CLOSE	
33017	20425L153-B22-B54	Heatcraft	5708L	L	75	40	18 w/ quick connects

1D=SPDT, no. 1 is common (white) - no label, no. 2 either opens or closes temp. rise - red label, no. 3 is opposite of no. 2 - blue label F= close on temperature rise, SPST L= open on temperature rise, SPST 2



## Change-Over Switches for Fan-Coil Systems

The MARS Series 390 change-over switches are used for summer-winter change-over of electric thermostats in hydronic heating - cooling fan-coil units.

### Features:

- Color coded leads allow easy installation
- SL-8 thermostat is enclosed in sealed case for trouble-free operation
- Snap-acting disc type, insures accurate temperature repeatability
- Can be mounted in any position
- UL and CSA listings available

### Installation:

The SL-8 change-over switch is located on the main run of the supply line where it can quickly sense the maximum temperature of the hot or cold water passing through. If the SL-8 switch is exposed to surrounding temperatures, thermal insulation should be wrapped around the switch case to maintain desired thermal response.

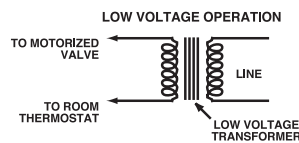
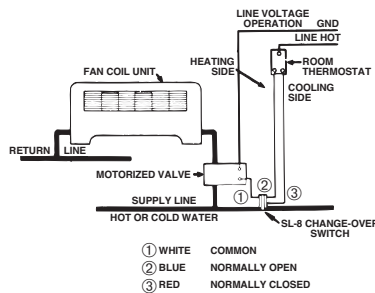
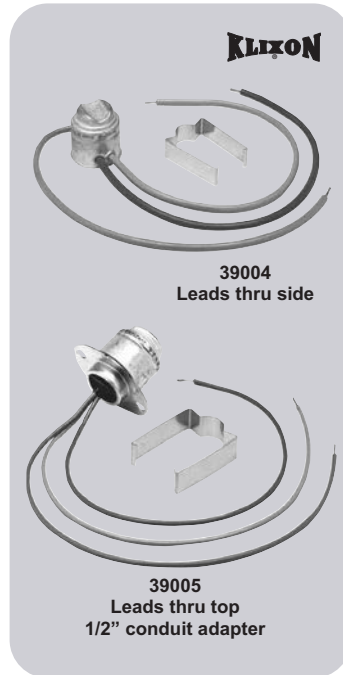

Honeywell No.	MARS No.	White Rodgers No.	MARS No.
L6076A	39004	752-1	39004
L6076B	39005	752-2	39005

MARS NO.	KLIXON KIT NO.	KLIXON NO.	DESCRIPTION
39004	SL8-5	20425D27-160-356	leads thru side of cup
39005	SL8-5A	20425D69-160-287	leads thru top of cup with 1/2" conduit adapter

## For Defrost Termination

MARS Series 330 defrost controls are designed to replace many defrost thermostats. The leads are of sufficient length for the connection to be made at the same location as was the control removed. The connection should be insulated in a manner similar to that on the original equipment.

The selection of the proper thermostat can be made by matching the temperature code of the thermostat removed to the code on the MARS Thermostat.



### Features:

- Refrigerators, A/C units, & heat pumps, dehumidifiers, icemakers or any place where a fixed temperature control is required in a wet or dirty environment.
- Thermostats have 32" leads.

Temp. Code	Use MARS No.	Temp. Code	Use MARS No.	Temp. Code	Use MARS No.
L40-3.0	33008	L58-4.3	33011	L65-4.0	33012
L42-2.0		L60-2.0		L67-4.2	
L45-3.0		L60-2.5		L70-4.0	
L45-3.0		L60-3.0		L75-5.0	
L55-1.5	33010	L60-3.5	33020	L80-3.0	33020
L55-2.0		L60-4.0		L80-4.0	
L55-2.5		L60-4.5		L80-4.5	
L55-3.0				L80-5.0	
L55-3.5					
L55-4.0					

MARS NO.	TEMP. CODE	OPENING TEMP. F°	CLOSING TEMP. F°
33008	L45	45	25
33010	L55	55	35
33011	L60	60	40
33012	L70	70	50
33020	L80	80	60

VOLTS	INDUCTIVE	
	F.L.A.	L.R.A.
120	5.8	25
240	2.9	70

## MARS Freeze Stat

The MARS 33101 is designed to help stop flood back to compressor crankcases caused by low ambient temperatures.

### Features:

- Simple to install
- Refrigerators, freezers, A/C, food dispensing equipment
- For use with 1" pipe, 1/2" radius
- 24" leads



MARS NO.	OPENING TEMP. F°	CLOSING TEMP. F°
33101	34	45

# Pressure Switches & MARS Pressure Switches

## Fixed Setting Pressure Controls

Low pressure controls.

**Specifications:**

- Contacts rated at 6 amps, 24-240 volts
- 18" leads

**Features:**

- Tamper proof construction
- Direct mounting on tubing
- UL & CSA recognized



MARS Pressure Switches deliver the reliability and performance that makes them the most trusted electromechanical sensor.

UL and CUL, Compact size, light weight for direct mounting, Factory Set, Hermetically Sealed Sensor.

5.8 FLA - 34.8 LRA @ 120 VAC, 2.9 FLA - 15.0 LRA @ 240 VAC, 100,000 Cycle Life at Rated Current.

### Low Pressure Cut-Out - Open on Pressure Drop, Automatic Reset Normally Open

MARS NO.	OPENING PRESSURE	RESET PRESSURE	NOTES
43341	5	20	1/4" Female Flare S.A.E. Mounting
43342	5	30	1/4" Female Flare S.A.E. Mounting
43343	10	25	1/4" Female Flare S.A.E. Mounting
43344	15	35	1/4" Female Flare S.A.E. Mounting
43345	20	45	1/4" Female Flare S.A.E. Mounting
43372	22	50	1/4" Copper Clad SS Tube w/38" leads
43373	25	40	Gold Contacts 1/4" Female Flare w/36" leads
43346	25	50	1/4" Female Flare S.A.E. Mounting
43347	25	65	1/4" Female Flare S.A.E. Mounting
43348	25	80	1/4" Female Flare S.A.E. Mounting
43349	35	60	1/4" Female Flare S.A.E. Mounting
43350	40	80	1/4" Female Flare S.A.E. Mounting
43351	45	60	1/4" Female Flare S.A.E. Mounting
43352	50	90	1/4" Female Flare S.A.E. Mounting
43374	50	95	1/4" Copper Clad SS Tube w/36" leads
43353	75	100	1/4" Female Flare S.A.E. Mounting
43375	90	120	1/4" Female Flare, w/18" leads
43354	150	225	1/4" Female Flare S.A.E. Mounting
43355	170	250	1/4" Female Flare S.A.E. Mounting

## Fixed Setting Pressure Controls High Pressure Cut-Outs

MARS offers the most complete line of high pressure cut-outs available.

**Specifications:**

- Contacts rated at 6 amps, 24-240 volts
- 1/4" female flare S.A.E. mounting
- 18" leads

**Features:**

- Tamper proof construction
- Direct mounting on tubing
- UL & CSA recognized



MARS Pressure Switches deliver the reliability and performance that makes them the most trusted electromechanical sensor.

UL and CUL, Compact size, light weight for direct mounting, Factory Set, Hermetically Sealed Sensor.

5.8 FLA - 34.8 LRA @ 120 VAC, 2.9 FLA - 15.0 LRA @ 240 VAC, 100,000 Cycle Life at Rated Current.

### High Pressure Cut-Out - Open on Pressure Rise, Automatic Reset, Normally Closed

MARS NO.	OPENING PRESSURE	RESET PRESSURE	NOTES
43337	200	150	1/4" Female Flare S.A.E. Mounting
43321	225	150	1/4" Female Flare S.A.E. Mounting
43322	250	150	1/4" Female Flare S.A.E. Mounting
43324	275	195	1/4" Female Flare S.A.E. Mounting
43325	300	200	1/4" Female Flare S.A.E. Mounting
43326	325	225	1/4" Female Flare S.A.E. Mounting
43320	350	245	1/4" Female Flare S.A.E. Mounting
43327	350	250	1/4" Female Flare S.A.E. Mounting
43328	375	275	1/4" Female Flare S.A.E. Mounting
43329	400	200	1/4" Female Flare S.A.E. Mounting
43330	400	280	1/4" Female Flare S.A.E. Mounting
43331	400	300	1/4" Female Flare S.A.E. Mounting w/24" leads (1 stripped, 1 w/1/4" female flag QC)
43311	410	290	1/4" Female Flare S.A.E. Mounting
43332	425	300	1/4" Female Flare S.A.E. Mounting
43333	425	325	1/4" Female Flare S.A.E. Mounting
43334	450	250	1/4" Female Flare S.A.E. Mounting
43365	590	418	1/4" Female Flare w/snubber
43335	600	475	1/4" Female Flare S.A.E. Mounting
43366	610	420	1/4" Copper Clad SS Tube, 90 degree elbow w/snubber
43339	630	480	1/4" Female Flare S.A.E. Mounting
43367	650	450	1/4" Copper Clad SS Tube w/snubber

## Condenser Fan Cycling Switches

Fan cycling switches provide refrigeration and air conditioning from low ambient conditions.

### Specifications:

- Contacts rated at 6 amps, 24-240 volts
- 1/4" female flare S.A.E. mounting
- 18" leads

### Features:

- Tamper proof construction
- Direct mounting on tubing
- UL & CSA recognized



43301

## Heat Pump Defrost Thermostats

MARS heat pump defrost thermostats are designed for direct replacement of most existing controls of this type. The temperature settings and tubing sizes have been carefully selected from the most popular OEM settings. Each MARS thermostat comes complete with extra long 54 inch leads, mounting clamp, and installation instructions for fast and simple field installation.



33490

### Features:

- Four controls cover most requirements
- Tapered mounting edge for maximum heat transfer
- Extra long 54 inch leads for simple wiring
- Individually boxed with mounting clamp and instructions
- UL & CUL listed

### Electrical Ratings:

Cycles X1000	Volts	FLA	LRA	Resistive Amps	VA
100	120VAC	5.8	34.8	10	125
100	240VAC	2.9	17.4	10	125
30	120VAC	10.0	40.0	-	-
30	240VAC	10.0	40.0	-	-
100	30VDC	-	-	1	-

## Fan Cycling - Close on Pressure Rise

MARS NO.	OPENING PRESSURE	RESET PRESSURE	NOTES
43301	75	100	1/4" Female Flare S.A.E. Mounting
43302	110	170	1/4" Female Flare S.A.E. Mounting
43303	125	265	1/4" Female Flare S.A.E. Mounting
43304	150	225	1/4" Female Flare S.A.E. Mounting
43305	190	275	1/4" Female Flare S.A.E. Mounting
43370	180	240	1/4" Female Flare, S.A.E. Mounting
43306	210	275	1/4" Female Flare S.A.E. Mounting
43307	300	400	1/4" Female Flare S.A.E. Mounting

## Manual Reset - High Pressure Cut Out Open on Pressure Rise



43312

MARS NO.	OPERATING TEMPERATURES F°		TUBE MOUNTING IN	LEADS IN
	OPEN	CLOSE		
33490	80	30	3/8	54
33492	80	30	1/2	54
33494	65	30	3/8	54
33496	65	30	1/2	54

MARS NO.	OPENING PRESSURE	RESET PRESSURE	NOTES
43312	375	Manual	1/4" Female Flare S.A.E. Mounting
43313	410	Manual	1/4" Female Flare S.A.E. Mounting
43314	415	Manual	Capillary Tube
43315	440	Manual	Capillary Tube
43316	475	Manual	1/4" Female Flare S.A.E. Mounting
43368	590	Manual	1/4" Female Flare w/snubber
43369	610	Manual	1/4" Female Flare w/snubber

# Compressor Heaters

## TUTCO™ Compressor Heaters for A/C and Refrigeration

**Features:**

- Corrosion resistant exterior
- High temperature silicone rubber element and insulated leads
- 30" leads
- Wattage for each model matches compressor requirements
- Completely moisture proof
- Installs quickly and easily
- Nominal power consumption
- UL & CSA Listed



### Application Reference Chart for TUTCO™ Compressor Heaters

Manufacturer	Model	MARS No.
Aspera	H	32605-32608
Aspera	J	32609-32611
Bendix/Westinghouse	A	32613
Bendix/Westinghouse	C, D	32601-32602
Bendix/Westinghouse	E	32605-32608
Bristol/Sundstrand	H10A, H21A, H2EA, H22A	32605-32608
Bristol/Sundstrand	H10B, H20B, H21B, H22B	32613
Bristol/Sundstrand	H10G, H20G, H21G, H22GN2NG-144	32617-32620
Carrier	6A25, 26, 28, 29, 6A35, 38, 45, 48	32605-32608
Carrier	6A88	32617-32620
Carlyisle	W (70-88)	32601-32602
Copeland	BR	32634-32635
Copeland	CR	32605-32608
Copeland	JR	32629-32630
Copeland	RR, SR	32613
Copeland	VR	32621-32624
Copeland	Y	32601-32602
Fedders/Chrysler	3009	32617-32620
Fedders/Chrysler	2870908	32631
Hitachi	1500FH4-H	32617-32620
Hitachi	305FH2-HE, 402FH2-HE, 505FH2-HE	32613-32616
Hitachi	753FH3-H, 1001FH4-H	32601-32602
Sanyo	CR15F, CR20F, CR33F	32631
Tecumseh	AB, AW	32613
Tecumseh	AH	32605-32608
Tecumseh	AJ	32609-32611
Tecumseh	AK	32629-32630
Tecumseh	B, C, CL, AG, AV	32601-32602
Tecumseh	FE, FB	32617-32620
Trane	D4340/7669	32609-32611
Trane	D4340/7670	32621-32624
Trane	D4350/689, D4359/690	32605-32608
Westinghouse	CD072, CD090	32605-32608
Westinghouse	CD072, CD090	32621-32624

MARS NO.	DESCRIPTION	VOLTS	WATTS	INCHES		SHAPE
				MIN.	MAX.	
32601	CH-100	240		30 3/16	37	
32602	CH-100-1	208	50	30 3/16	37	OVL
32605	CH-101	240		27 7/16	34 1/4	
32608	CH-101-3	480		27 7/16	34 1/4	OVL
32609	CH-102	240		25 3/4	32 9/16	
32610	CH-102-1	208	60	25 3/4	32 9/16	OVL
32611	CH-102-2	120		25 3/4	32 9/16	
32613	CH-103	240	45	24 3/4	31 9/16	OVL
32617	CH-104	240		41 1/2	48 5/16	
32619	CH-104-2	120	75	41 1/2	48 5/16	RND
32620	CH-104-3	480		41 1/2	48 5/16	
32621	CH-105	240		32 1/2	39 5/16	
32624	CH-105-3	480	50	32 1/2	39 5/16	RND
32629	CH-135	240		20 5/16	27 1/8	
32630	CH-135-2	120	45	20 5/16	27 1/8	OVL
32631	CH-197	240	25	13 3/4	20 9/16	RND
32634	CH-202-2	120	70	33 3/4	36 3/4	RND
32635	CH-202-3	480		33 3/4	36 3/4	

## Direct Replacement Crankcase Heaters for Copeland

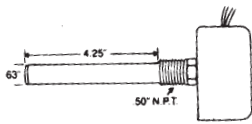
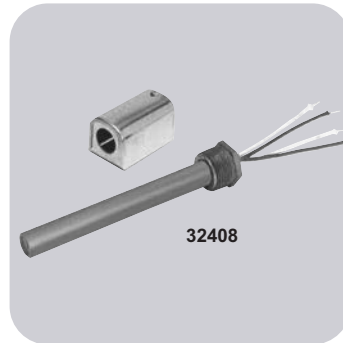

Figure 1



## Crankcase Heaters for Copeland

NOTE: All heaters requiring clips or brackets are packaged with the appropriate clips or brackets required.

MARS NO.	COPELAND NO.	WATTS	VOLTS	HEATER LENGTH IN.	FIGURE	COMPRESSOR MODEL	ACCESSORIES
32408	518-0002-01	100	480	4.25	1	4R, 6R, 6T, 4D, 6D	-

## Self Regulating Crankcase Heaters

MARS self-regulating crankcase heaters are designed for use with refrigeration compressors up to 5HP and 40 inches in circumference. These heating cables provide peak heat during cold periods and reduced heat when the air temperature rises and should be used in non-hazardous areas.



- Cold length: 30"
- Heat cable length: 50"

MARS NO.	TYPE	WATTS	VOLTS
70970	Self Regulating	32W @ 50°F • 60W @ 0°F	120
70971	Self Regulating	32W @ 50°F • 60W @ 0°F	240

## Direct Replacement Crankcase Heaters for Carrier

Figure 1

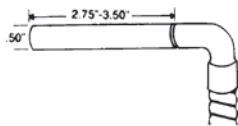

## Crankcase Heaters for Carrier

MARS NO.	CARRIER NO.	WATTS	VOLTS	HEATER LENGTH IN.	LEAD LENGTH IN.	FIGURE	COMPRESSOR MODEL
32472	HT36FL379	125	120	2.75	60	1	EM:06DM: 306B:50EQ
32474	HT36FL479	125	240	2.75	68	1	EM:06DM: 30HR:30HS

# Electric Heat

## Replacement Coil Kits and Accessories for Electric Heat

MARS Replacement coil kits for electric heat let you repair strip heaters quickly and economically. Each kit contains one close wound, stretch to length, resistance coil with welded terminal bolts; two each male and female ceramic terminal insulators; two each .375 and .450 inch standard ceramic bushings; two each .375 and .450 inch extra long ceramic bushings; necessary nuts, washers, and installation instructions.

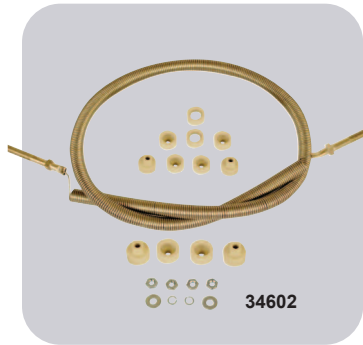

Select the right MARS kit from the chart below and order one kit for each circuit to be repaired. Thermal fuse links are rated 22 amp resistor, 15 amp inducer at 120 and 240 VAC.

**Features:**

- Welded terminal bolts for low resistance and long life
- Close wound coil, stretch to fit many applications
- Complete with bushings, insulators and hardware

MARS NO.	WATTAGE AT				STRETCHED LENGTH			
	240V	208V	480V	277V	INCHES		METERS	
					MIN	MAX	MIN	MAX
34602	5000	3750	—	—	44.62	127.48	1.13	3.24
34604	—	—	5000	—	61.78	176.53	1.57	4.48
34606	—	—	—	5000	59.44	169.82	1.51	4.31
34608	3500	2625	—	—	50.75	145.00	1.29	3.68
34610	—	—	3500	—	42.27	120.76	1.07	3.07
34614	2000	1500	—	—	25.90	74.01	0.66	1.88
34616	2500	1875	—	—	30.89	88.26	0.78	2.24
34620	—	—	—	2500	27.61	78.87	0.70	2.00
34626	—	—	4500	—	46.05	131.98	1.17	3.35
34630	—	—	2000	—	32.00	108.00	0.81	2.74
34652	6600	4950	—	—	70.56	201.59	1.79	5.12
34656	6000	4500	—	—	54.43	155.50	1.38	3.95
34658	—	—	6000	—	71.88	205.38	1.83	5.22
34660 <sup>(1)</sup>	5000	3756	—	—	25.00	70.00	—	—

(1) Larger diameter coil - 5/8"

## Thermal Fuse Links\*



MARS NO.	°F	°C	DESCRIPTION
34700	204	95.56	Fuse Link
34702	283	139.45	Fuse Link
34704	333	167.22	Fuse Link
34706	300	148.89	Fuse Link
34708	300	148.89	Fuse Link—Round Ceramic Base
34710	227	108.33	Fuse Link—Oblong Ceramic Base
34712	300	148.89	Fuse Link—Oblong Ceramic Base

\*10 per pack

## Replacement Coil Economy Kits

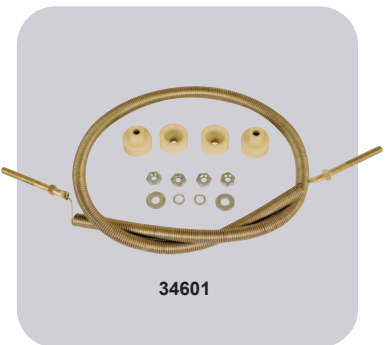

MARS NO.	DESCRIPTION
34600	5000 Watt @ 240 V; includes coil, insulators & hardware
34601	5000 Watt @ 240 V; includes 300° fuse link, coil, insulators & hardware

## Electric Heat Sequencers

A new simple method for selecting and replacing electric heat sequencers with only five basic controls. Replace sequencers in almost any existing system.

Sequencer selection:

- A. Determine the number of circuits to be switched. (Electrical rating of auxiliary switch same as main switch.) When more than one (1) sequencer is required the sequencers are to be wired in series with the last switch in each sequencer energizing the control circuit of the next sequencer.
- B. Select from the chart the sequencers needed for the number of circuits to be switched. These sequencers may be wired in series to allow sequencing of virtually any number of heating elements and fans.

If the sequencers control the fan/blower circuit, the first switch (M1-M2) of each sequencer must always control the fan. This provides a fan interlock to insure that the fan will remain on until all elements are de-energized.

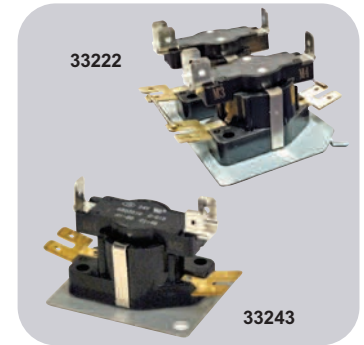

### Features:

- Solid State dependability
- Replaces Honeywell and White-Rodgers
- Ambient rated from 20°F to 160°F
- Used on both separate blower and element and combination blower and element systems
- Total 24 volt control
- Standard double quick-connect terminals for combination fan and element systems
- Full-load-rated auxiliary contacts
- 7.2 KW combination fan and element rated contacts (23A resistive, 7A motor load)
- Non-positional
- Voltage and ambient self compensating positive temperature coefficient (PTC) heater elements
- Individually packaged with wiring diagrams for up to seven element furnaces.
- UL and CSA listing available

### Schematic

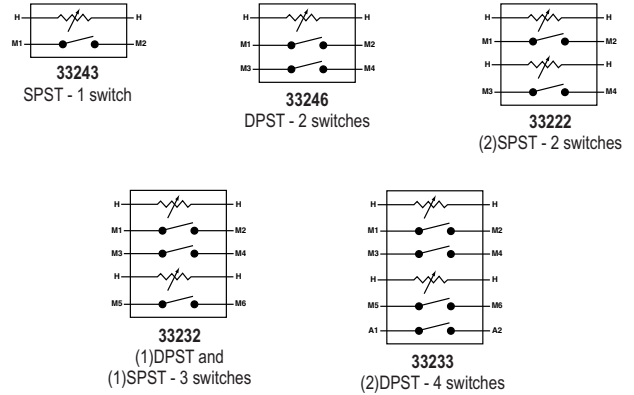

### Contact Rating Chart

VAC	RES AMPS	FLA	LRA	PILOT DUTY VA
120	30	23	84	672
240	30	23	60	960
277	23	23	42	775
480	12.5	5	10	400

NO. OF SWITCHES	MARS NO.	REPLACES KLIXON NO.	SWITCH TIMING: MIN-MAX IN SECONDS									
			SWITCH SEQUENCE		SWITCH NO.1 TERMINALS M1 / M2		SWITCH NO.2 TERMINALS M3 / M4		SWITCH NO.3 TERMINALS M5 / M6		SWITCH NO.4 (2) TERMINALS A1 / A2	
			FIRST ON	LAST ON / LAST OFF	ON	OFF	ON	OFF	ON	OFF	ON	OFF
1	33243	6000AOM	(1)		1-60	1-45						
2	33246	6000EOM	(1)		1-60	1-45	1-60	1-45				
2	33222	51172-22	No. 1	No. 2	1-24	45-75	30-70	1-40				
3	33232	51172-32	No. 1, No. 2	No. 3	1-24	45-75	1-24	45-75	30-70	1-40		
4	33233	51172-33	No. 1, No. 2	No. 3, No. 4	1-24	45-75	1-24	45-75	30-70	1-40	30-70	1-40

# Relays & Sequencers

## Thermal Time Delay Relays Sequencers

These time delay relays are used for a variety of applications in heating and air conditioning. They operate by means of a solid state PTC (positive temperature coefficient) device which heats up as current passes through it from the control circuit. This heat causes a positive, snap-acting disc to make or break the necessary contacts.

**Features:**

- Shock & vibration resistant internal snap action automatic reset switch mechanism assures positive make/ break action
- Non-positional
- Wide selection for any application
- Voltage and ambient compensated
- UL and CSA listed
- Used for electric heat, air conditioning, heat pumps, gas & oil furnaces, unit heaters and commercial refrigeration

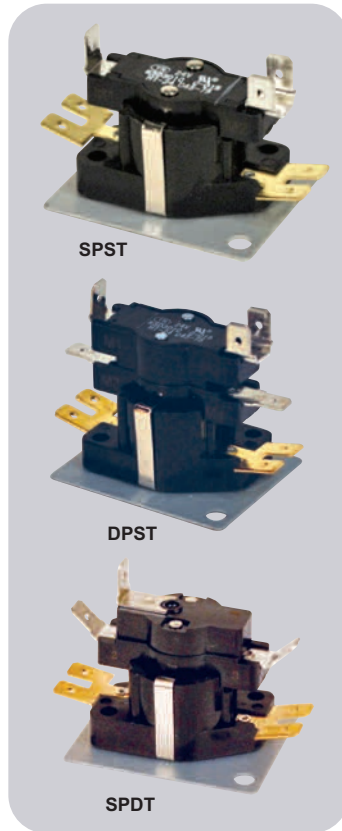

**Diagrams:**

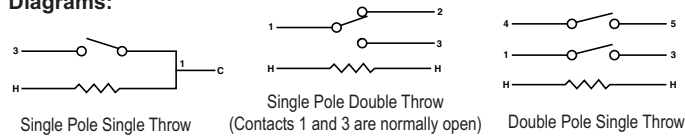

MARS NO.	REPLACES KLIXON NO.	SWITCH TYPE	CONTROL VOLTAGE	DELAY (SEC.)	
				ON	OFF
33215	G0-18		24	1-60	1-45
33217	G4-9		240	20-70	20-80
33241	AOM		24	1-24	45-75
33242	AOM	SPST N.O.	24	30-75	1-40
33243	AOM		24	1-60	1-45
33244	EOM		24	1-24	45-75
33245	EOM	DPST N.O.	24	30-75	1-40
33246	EOM		24	1-60	1-45
33247	COM-21	SPDT 1 & 3 N.O.	24	1-24	15-75
33256	E4	DPST N.O.	120	20-70	20-80
33265	E4	DPST N.O.	240	30-110	15-65
33266	E4		240	20-70	20-80
33267	C4M-13	SPDT 1 & 3 N.O.	240	20-70	20-80

## Electric Heat Sequencers

The MARS heat sequencers are used in a variety of applications, including electric furnaces, baseboard heaters, heat pump blower control and heating element control. The sequencers stage electric heat to prevent circuit overload. These units operate by means of a PTC (positive temperature coefficient). The PTC is self current limiting, ensuring stable switching action over a wide range of voltages.

**Features:**

- Solid state dependability
- Replaces Honeywell, White Rodgers, and Klixon
- 12.5A to 25A contact ratings
- Quick connect terminals
- Various mounting positions
- Shock & vibration resistant
- Ambient rated from -50°F to 165°F
- Full-load rated auxiliary contacts

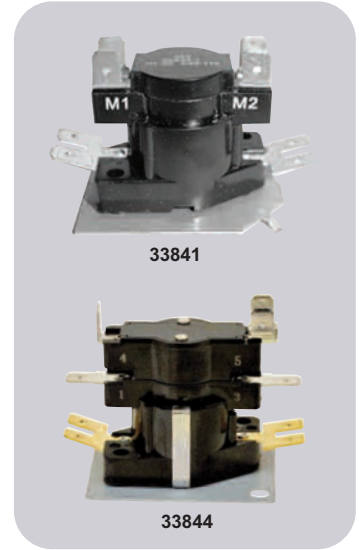

### Single Load Contact Ratings

VAC	RESISTIVE (NON-INDUCTIVE)			MOTOR RATINGS (INDUCTIVE)		
	WATTS	AMPS	FULL LOAD	LOCKED ROTOR	PILOT DUTY	
120	3000	25	10A	60A	125VA	
240	6000	25	5A	30A	125VA	
480	6000	12.5	3A	18A	480VA	

Combined Load Ratings: 30A @ 240VAC - Total: 23A non-inductive + 7FLA / 42LRA inductive  
Life at rated current: 10,000 cycles

MARS NO.	TIM.	SW.	M1-M2	M3-M4	M5-M6	M7-M8	M9-M10	M1-M2	M3-M4	M5-M6	M7-M8	M9-M10
33841	1	1	1-20	-	-	-	-	40-110	-	-	-	-
33842	1	1	-	-	30-90	-	-	-	-	1-30	-	-
33844 <sup>(1)</sup>	1	2	1-20 ■	1-20	-	-	-	40-110 ■	0-110	-	-	-
33845	1	2	-	-	30-90 ■	30-90	-	-	-	1-30 ■	1-30	-
33832 <sup>(1)</sup>	2	3	1-110 ■	1-110	1-110	-	-	1-110 ■	1-110	1-110	-	-
33833 <sup>(1)</sup>	2	4	1-110 ■	1-110	1-110 ■	1-110	-	1-110 ■	1-110	1-110 ■	1-110	-
33848 <sup>(1)(2)</sup>	4	5	1-160 ■	1-160	1-160	1-110	1-160	1-160 ■	1-160	1-160	1-160	1-160

(1) M1-M2 and M3-M4 are always first switches to turn ON and to turn OFF. All other switches are random ON and random OFF  
(2) #33848 - switch contacts designated F1-F2 instead of M1-M2

■ These contacts switch simultaneously  
ON TIME – Elapsed time to make contacts after heater is energized (Min. to Max.)  
OFF TIME – Elapsed time to make contacts after heater is de-energized (Min. to Max.)  
OFF Timings determined after PTC heater has been electrified for a total of 5 minutes.



## Heating Applications

MARS Series 390 thermostats are designed for quick on-the-job replacements. One thermostat, when used in conjunction with only one listed, can solve almost any mounting problems you encounter.

Our thermostats have been carefully selected to cover the widest temperature ranges with the fewest models.

### Features:

- Widest range of replacements in the industry
- UL and CSA listings available

### Electrical Rating

		Terminals 1-3	Terminals* 1-2
FL Amps	120v	10	5.8
	240v	5	2.9
Res. Amps	120v	25	10
	240/277v	25	5
Pilot Duty	120/240/277v	125va	125va

\*For Spdt Thermostats



## Fan Switches - Close On Temperature Rise

MARS NO.	KLIXON TEMP. CODE	TEMPERATURE °F	
		OPEN	CLOSE
39006	F110-2	90	110
39007	F120-2	100	120
39008	F130-2	110	130
39009	F140-2	120	140
39010	F150-2	130	150
39011	F160-2	140	160

## Manual Reset Limit Switches - Open On Temperature Rise

MARS NO.	REPLACES KLIXON TEMP. CODE	TEMPERATURE °F
		OPEN °F
39099	MR125	125
39037	MR140	140
39038	MR150	150
39039	MR160	160
39095	MR170	170
39096	MR180	180
39097	MR190	190
39098	MR200	200
39040	MR210	210
39042	MR240	240

## Limit Switches - Open On Temperature Rise

MARS NO.	KLIXON TEMP. CODE	TEMPERATURE °F	
		CLOSE	OPEN
39086	L125-2	105	125
39087	L130-4	90	130
39018	L140-4	100	140
39019	L150-4	110	150
39020	L160-4	120	160
39021	L170-4	130	170
39022	L180-4	140	180
39023	L190-4	150	190
39024	L200-4	160	200
39025	L210-4	170	210
39026	L220-4	180	220
39027	L230-4	190	230
39028	L240-4	200	240
39029	L250-4	210	250
39030	L270-4	230	270
39031	L300-4	260	300
39033	L350-4	310	350

## Single Pole Double Throw Switches

MARS NO.	KLIXON TEMP. CODE	TEMPERATURE °F	
		1-2 OPEN	1-2 CLOSE
39078	D140-2	120	140
39045	D150-2	130	150
39081	D170-2	150	170

## Adjustable Fan or Limit Thermostats

MARS adjustable fan or limit thermostats let you reduce inventory and still have on hand the most popular thermostat ratings.

MARS adjustable thermostats are easily set for the desired temperature by turning the indicator dial built into the control. Each MARS adjustable thermostat features integral 2 hole oval mounting flanges.



### Features:

- Easy dial adjustment
- Six controls cover most requirements
- Integral oval flange
- UL and CSA listings available

MARS NO.	TYPE	RANGE °F	DIFF. °F	SWITCHING ACTION
39205	Fan	90-130	20	Close on rise
39210	Fan	140-180	20	Close on rise
39220	Limit	135-175	40	Open on rise
39225	Limit	175-215	40	Open on rise
39230	Limit	210-250	40	Open on rise
39235	Limit	250-290	40	Open on rise

## Cross Reference Information

GEM NO.	MARS NO.	WHITE-RODGERS NO.	MARS NO.	MARS 2	MARS NO.
AT 012	39220	3F05-1	39205	35205	39205
AT 013	39225	3F05-2	39210	35220	39220
AT 014	39230	3L05-1	39220	35225	39225
AT 015	39235	3L05-2	39225	35230	39230
AT 021	39205	3L05-3	39230	35235	39235
AT 022	39210				

## Cross Reference Information

WR NO.	MARS REPLACEMENT	WR NO.	MARS REPLACEMENT	WR NO.	MARS REPLACEMENT
3F01-110	39006	3L01-120	39086	3L02-160	39039
3F01-120	39007	3L01-130	39087	3L02-170	39095
3F01-130	39008	3L01-140	39018	3L02-180	39096
3F01-140	39009	3L01-180	39022	3L02-190	39097
3F01-150	39010	3L01-190	39023	3L02-200	39098
3F01-160	39011	3L01-200	39024		
3F01-180	39112	3L01-230	39027	3L03-140	39078
3F01-200	39113	3L01-250	39029	3L03-190	39147
3F01-350	39017	3L01-300	39031	3L03-325	39093
		3L01-350	39033		
		3L01-550	39036		

## Fan & Limit Disc Thermostats

### Electric Heat High Limit Thermostats

MARS electric heat high limit thermostats are designed for easy accurate replacement of OEM thermostats on electric furnaces. Temperature ratings and differentials have been carefully selected for safe operation.

MARS electric heat high limit thermostats feature an exposed matte finish disc for fast response. Easy matching of OEM mountings using the intergal round flange or accessory oval flange.

**Features:**

- Exposed matte finish disc for fast response
- Twelve models replace most popular OEM thermostats
- Individually bagged with instructions
- UL and CSA listings available



MARS NO.	TEMPERATURE °F		
	OPEN	CLOSE	DIFFERENTIAL
39310	110	90	20
39312	120	100	20
39314	130	100	30
39316	140	100	40
39318	145	105	40
39320	150	110	40
39324	160	120	40
39326	170	130	40
39328	180	140	40
39330	190	150	40

### Pro-Series Heating Service Kit

MARS has selected the most popular fan and limit switches used in heating applications. Each switch has an integral small oval flange to duplicate the most popular mounting. UL and CSA listings available.



MARS NO.	SWITCH TYPE	KLIXON TEMP. CODE	TEMPERATURE °F		TEMPERATURE °C	
			CLOSE	OPEN	CLOSE	OPEN
39008	Fan	F130-2	130	110	54	43
39009	Fan	F140-2	140	120	60	49
39010	Fan	F150-2	150	130	66	54
39011	Fan	F160-2	160	140	71	60
39022	Limit	L180-4	140	180	60	82
39023	Limit	L190-4	150	190	66	88
39024	Limit	L200-4	160	200	71	93

### Home Laundry Applications

MARS has carefully selected the most popular multi-purpose thermostats for home laundry and drier equipment. MARS Operating Limit Thermostats range from 125°F to 180°F and have narrow differentials (20°F).

**Features:**

- UL and CSA listings available.



### Operating Limit Thermostats — Open On Temperature Rise

MARS NO.	KLIXON TEMP. CODE	TEMP °F-OPEN	TEMP. °F-CLOSE
39086	L125-2	125	105
39055	L130-2	130	110
39048	L180-2	180	160

### MARS Thermocouples

MARS universal replacement thermocouples are fully equipped with fittings and necessary hardware for quick and easy installation.

Each kit is packaged on a display card for easy identification.

**Features:**

- High temperature stainless steel element for long life and dependable operation
- Fully equipped with fittings and necessary hardware for quick and easy installation
- Individually display packaged for protection and easy identification



MARS NO.	MODEL NO.	LENGTH INCHES
72218	TC-18P	18
72224	TC-24P	24
72230	TC-30P	30
72236	TC-36P	36
72248	TC-48P	48

## MARS Universal Silicon Nitride Igniter

MARS Universal Silicon Nitride Igniter is designed to replace over 100 silicon nitride igniter applications. The universal bracket kit is used in a simple series of combinations for a quick and easy installation. Extremely low iron content makes the MARS Universal Silicon Nitride Igniter very durable and reliable. Low energy consumption makes it perfect for any 120 VAC application.

### Features:

- Gas fired forced air furnaces and boilers
- Easy to install
- Universal bracket fits most furnaces
- Fits over 100 applications

### Specifications:

- Input voltage 120vac
- Time to ignition temperature: 16 seconds
- CSA certified
- Steady current 1.3 amps (± 0.3 amps @ 120v)

MARS NO.	DESCRIPTION
68040	Universal SiN Round Silicone Nitride Igniter



## Gas Furnace Igniters

- Compatible with 17, 34, and 45 second warm-up modules
- Full 115/120 volt rated (no step down module required for silicon nitride)
- Wire nuts or OEM plugs and mounting hardware included
- New laminated pictorial cross reference and contractor tri-folds available

**Flat silicon carbide:** The most economical solution.

**Silicon nitride:** The newest technology is virtually indestructible.

### Direct Replacements

MARS NO.	KIT CONTENTS	REPLACES
67909	Flat Surface Igniter with 19" leads with sleeving and connector	Coleman 1474-051P, 052P
67914	Flat Surface Igniter with 5.5" leads and connector	Robertshaw 41-401, Amana 1004 1601, B1336102, D99182, Trianco-Heatmaker 2600-359, White Rodgers 767A-309, 767A-356
67915	Flat Surface Igniter with 24" leads and wire nuts	Robertshaw 41-238, 41-242, 41-402, Armstrong 38322B001, Clare C-238, C-242, DMO 20834, 26789, Dornback 271W, Trane 340039P01, IGN23, White Rodgers 767A-371, Williamson 09050
67916	Flat Surface Igniter with 5.5" leads and wire nuts	Robertshaw 41-403, Raypak 600915, Snyder General 1380654, Trane B138196P01, IGN26, IGN30, Weil McLain 511-330-193
67917	Flat Surface Igniter with 9" leads and wire nuts	Robertshaw 41-405, White Rodgers 767A-361, York 025-27766-000, 025-27774-000, 025-29043-000, 025-29050-000
67918	Flat Surface Igniter with 5" leads and connector	Robertshaw 41-407, Trane B144676P02, IGN30
67919	Flat Surface Igniter with 5" leads and connector	Robertshaw 41-408, Rheem 62-22868-92, 62-22868-93, Trane B340039P01
67920	Flat Surface Igniter with 5" leads and connector	Robertshaw 41-409, Carrier LH332S001, 002, 003, 004, Ducane 20015201, Snyder General 1380672, 1380680, Trane IGN26, Weil McLain 511-330-139
67923	Flat Surface Igniter with 5.5" leads and connector	York 025-32625-000
67924	Flat Surface Igniter with 5" leads and connector, Mounting bracket attached	Goodman B1401015, B1401018S, Modine 5H075032B
67925	Flat Surface Igniter with 9" leads and wire nut, Gasket	Robertshaw 41-406, Glowcore HSRK-7, Lochinvar PLT2400, Surfaceigniter FY009, Weil-McLain 511-330-188, White Rodgers 767A-374
68013	Flat Surface Igniter with 5" leads and connector, Bracket	Robertshaw 41-411, Rheem 62-22868-82
68014	Flat Surface Igniter with 5" leads and connector, Bracket	Robertshaw 41-412, 41-414, Goodman B1401009, Intercity 1009604
68015	Flat Surface Igniter with 8.5" leads and connector, Mounting bracket and gasket	Rheem 62-22669-92
68016	Flat Surface Igniter with 5" leads and connector	Robertshaw 41-410, Trane B144676P01, IGN30
68017	Flat Surface Igniter with 5" leads and connector	Robertshaw 41-404, Weil McLain 511-330-190

### Universal

MARS NO.	KIT CONTENTS	REPLACES
67900	Flat Surface Igniter with 14" leads, Includes 3 brackets, wire sleeving, mounting screw, 2 wire nuts, cross reference list, and instruction sheet	Replacement for flat and spiral igniters in over 50 furnace applications

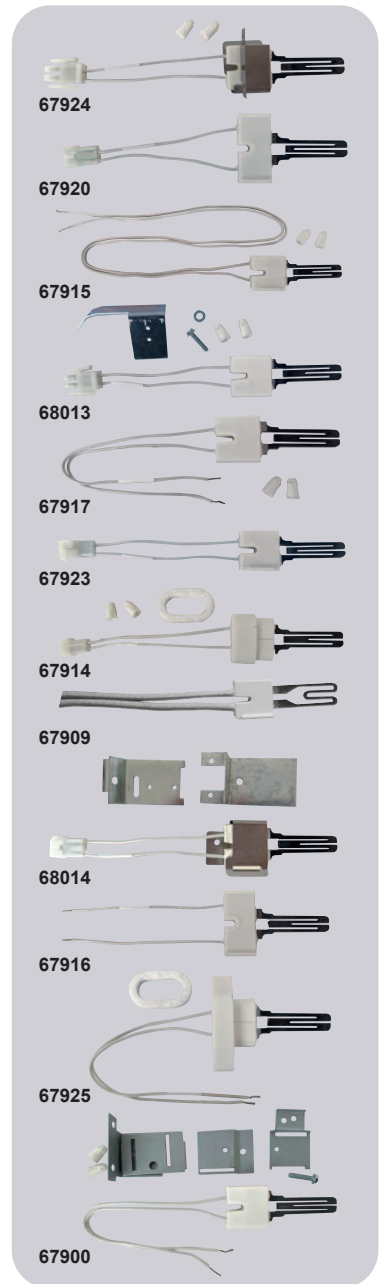

# Flame Sensors

## Flame Sensors

MARS flame sensors are direct OEM replacements. False shutdowns can occur in gas furnaces due to a built up carbon on the flame rod. Incorrect cleaning procedures can also damage the flame rod. Replacing a flame sensor that has triggered a false shutdown is the best preventative maintenance and eliminates nuisance service calls.

- Direct OEM Replacements
- Improved Service Life
- OEM Mounting Brackets
- Ceramic Insulators

MARS No.	Replaces OEM	OEM Part Number
67680	Goodman	10735201
67681	Source 1	SI-02537499000
67682	Source 1	SI-02530788700
67683	Goodman	0130F00010
67684	Allied	44L48
67685	Source 1	SI-02535306000
67686	Source 1	SI-02527773700
67687	Source 1	SI-02535354000
67688	Goodman	B1172601
67689	Source 1	SI-02530802000

