

TECHNICAL SPECIFICATIONS

R6GN Series

Single Packaged Gas/Electric Units with R-410A

R6GN 10.8 EER Commercial System 12½ and 15 Ton Units

These units offer flexibility in the replacement market. The 12½ and 15 ton units are designed specifically for retrofit applications and are compatible with most standard footprints. They take less time to install and retrofit as they directly replace Carrier 48DP & 48DR series, making the contractor's job more profitable. These units are compliant with the 2007 requirements of ASHRAE 90.1, Addendum S.



Model R6GN-150 Shown

WARRANTY

- Commercial Warranty
- 1 year limited parts
- 5 year compressor
- 10 year limited heat exchanger.

FEATURES and BENEFITS

- **Baserails:** Provide lifting points for ease of installation.
- **Convertible Air Delivery:** Fits most standard applications and easily converts to horizontal airflow with horizontal roof curb.
- **Fully Insulated Bottom Pan:** Helps ensure quiet operation and prevents condensation.
- **Quick-Release Filter Access Panels:** Requires no special servicing tools.
- **Hi/Low Pressure Switches:** Ensures long compressor life.
- **18-Gauge Precoated Paint:** Promotes corrosion resistance and long life.
- **Two-Stage Cooling:** Offers cooling ranges from 78,000/148,000 to 94,000/180,000 Btu/h. Dual refrigeration circuits.
- **Two-Stage Heating :** Offers heat ranges from 180,000 to 315,000 Btu/h.
- **For Easy Service:** Hi/low service ports allow quick access without disrupting operation. Proven, industry standard components for service and availability.
- **R-410A Refrigerant:** Earth friendly-non-ozone depleting refrigerant.
- **Crankcase heater:** Prevents damaging flooded starts and future compressor failures.
- **Plastic Mesh Hail Guard:** A guard that will never rust and protects the units coil from being damaged.
- **Compatibility:** Fits most standard rooftop applications- can be easily adapted for exceptions. Footprint database available for cross-reference at <http://www.rooftopsystems.com> under the "Adapter Quote" tab.
- **Freeze protection thermostat:** Provides reliable compressor operation.

FACTORY INSTALLED OPTIONS, CONTACT NORDYNE INSIDE SALES

- Economizer
- High Static Drive
- 115V Convenience Outlet

FIELD INSTALLED ACCESSORIES

- Compressor Lockout Protection
- Low Ambient Kit
- Horizontal Return Air Kit
- Economizer
- Fresh Air Kit
- CO2 Sensor
- Duct Smoke Detector
- LP Gas/High Elevation Conversion Kit
- Nat. Gas/High Elevation Conversion Kit
- Differential Enthalpy Control

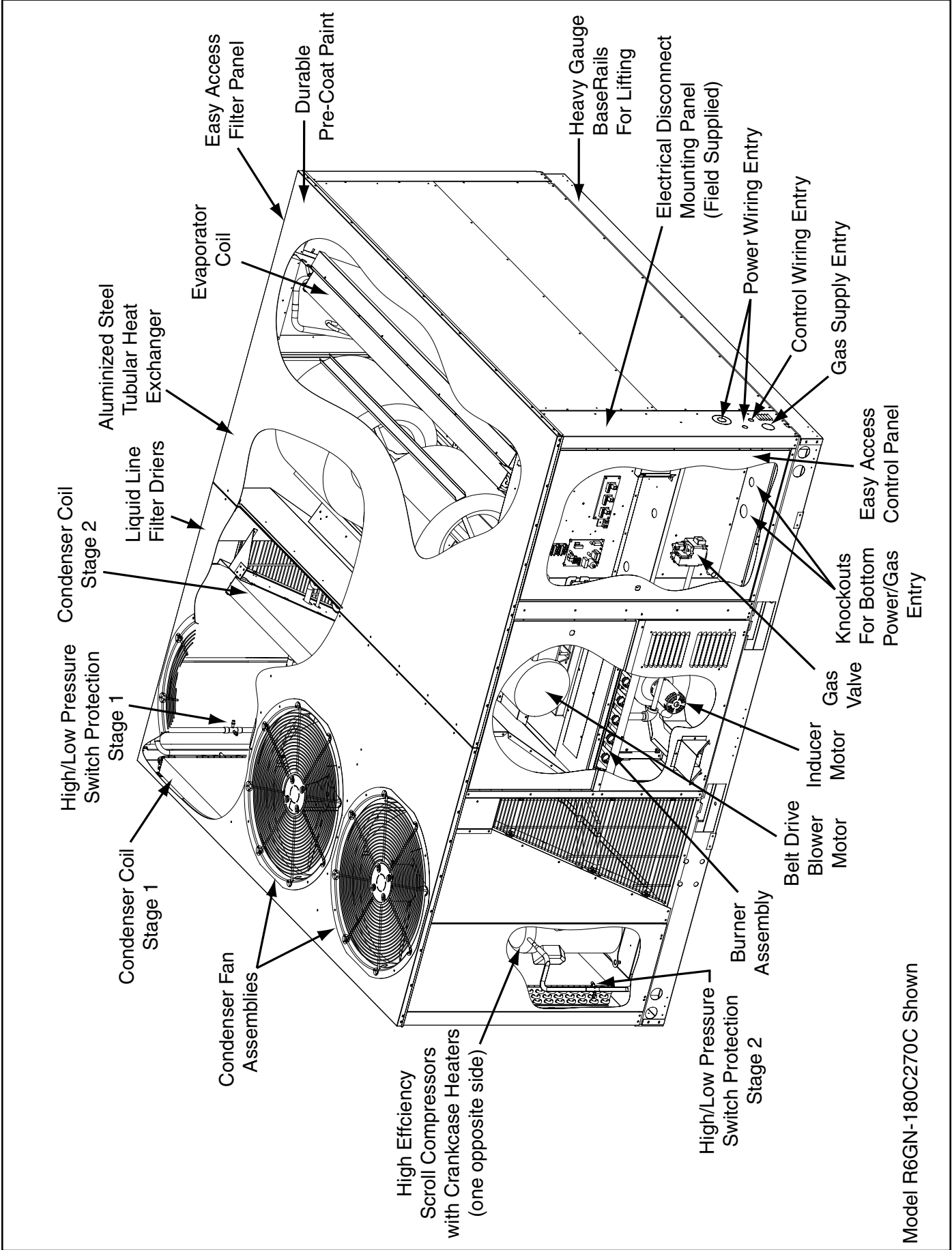

Model R6GN-180C270C Shown

MODEL IDENTIFICATION CODE

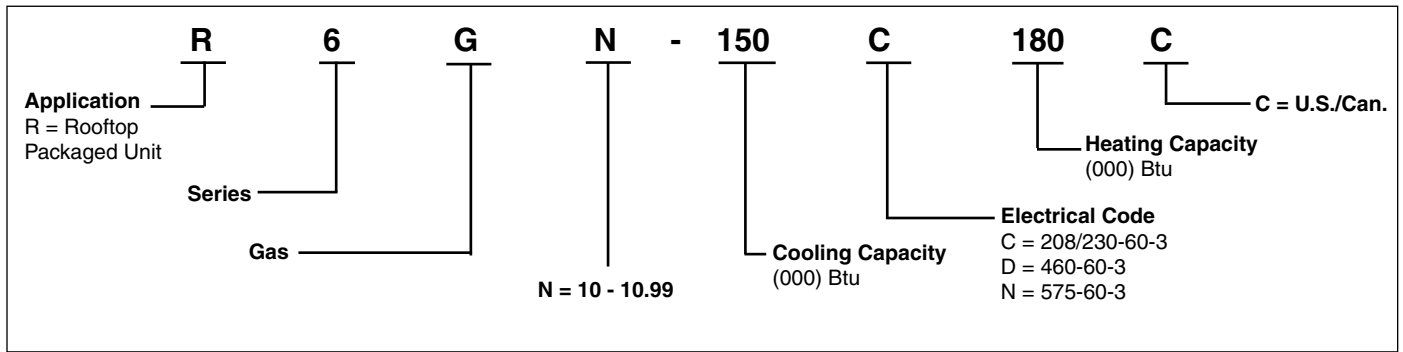

R6GN-150/180 SERIES – PHYSICAL DATA

Dimensions shown in inches (mm)

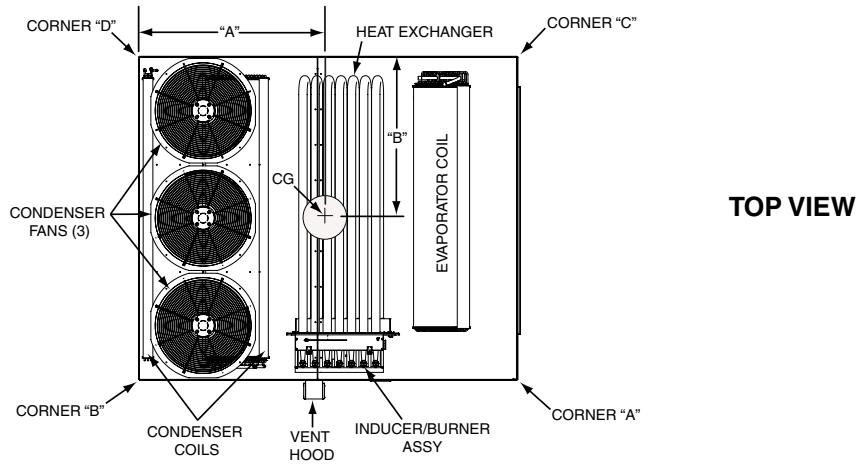

R6GN-180 Series

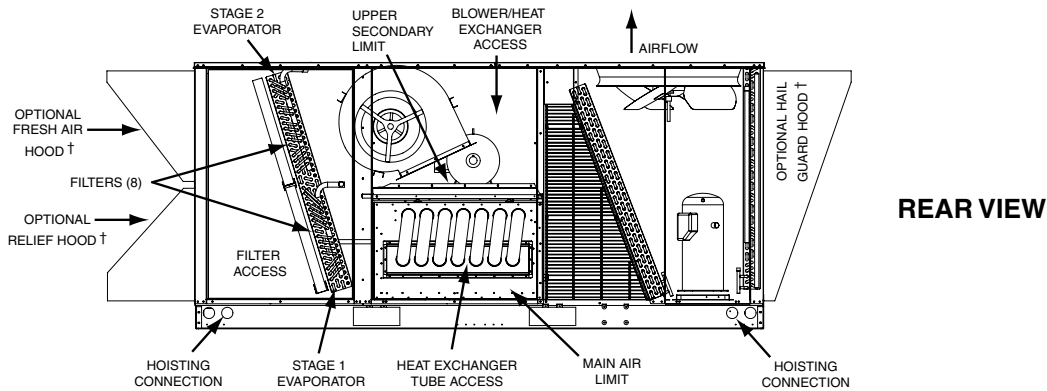
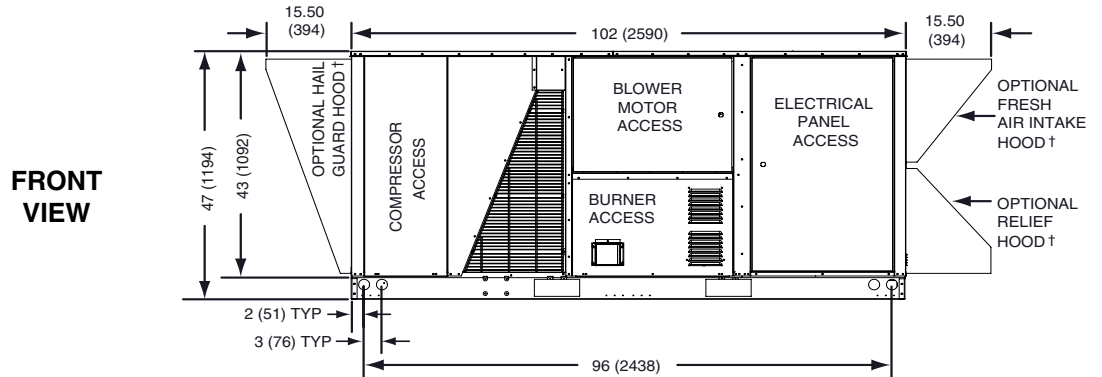

R6GN-150/180 SERIES – PHYSICAL DATA

Dimensions shown in inches (mm)

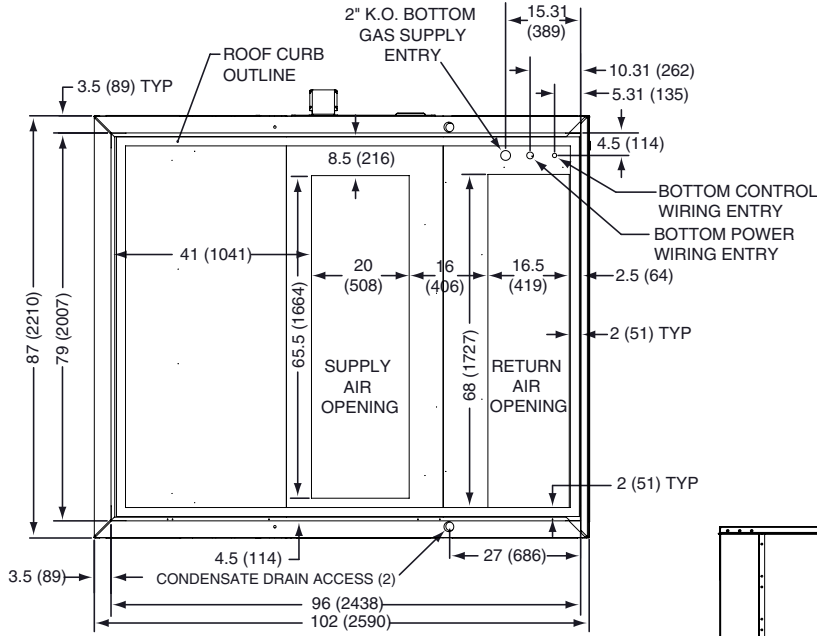

BOTTOM VIEW

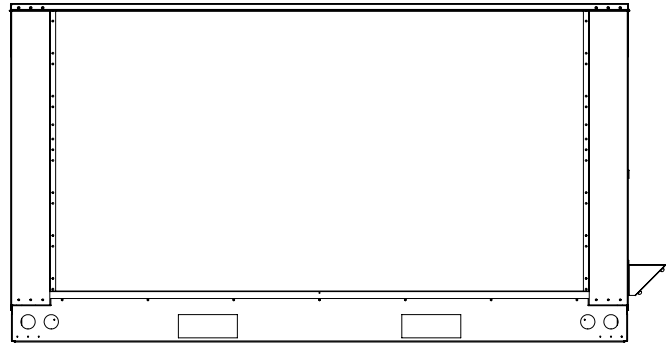

CONDENSER END

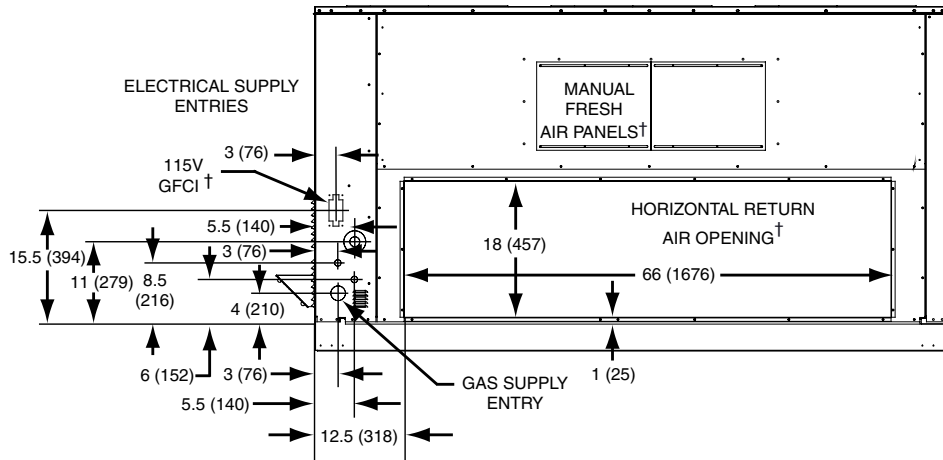

EVAPORATOR / FILTER END

Model No.	Unit Weight ‡		Shipping Weight		Center of Gravity Inches (mm)		Corner Weights							
	Lbs.	Kg.	Lbs.	Kg.	A	B	A		B		C		D	
							Lbs.	Kg.	Lbs.	Kg.	Lbs.	Kg.	Lbs.	Kg.
R6GN-150	1,730	786	1,944	884	48.75 (1,238)	44.5 (1,130)	430	195	460	209	405	184	435	198
R6GN-180	1,830	832	2,044	929	47.75 (1,213)	44.75 (1,137)	445	202	501	228	415	189	468	213

* Baseraills are not intended to be removed. Information provided is total unit height for horizontal duct applications or height dimension added to selected roof curb height for vertical duct applications.

† Field installed accessories required. ‡ Unit weight without packaging or field installed accessories.

SPECIFICATIONS AND ELECTRICAL DATA

Model R6GN-	150C180C	150D180C	150C270C	150D270C	180C270C	180D270C	180C315C	180D315C
Performance Data								
Gross Cooling Capacity (High) Btuh	154,200	154,200	154,200	154,200	187,200	187,200	187,200	187,200
¹ Net Cooling Capacity (High) Btuh	148,000	148,000	148,000	148,000	180,000	180,000	180,000	180,000
¹ Net Cooling Capacity (Low) Btuh	78,000	78,000	78,000	78,000	94,000	94,000	94,000	94,000
¹ AHRI Rated Airflow - C.F.M.	5,400	5,400	5,400	5,400	5,625	5,625	5,625	5,625
² Cooling - Efficiency E.E.R. (Btu/Watt)	10.80	10.80	10.80	10.80	10.80	10.80	10.80	10.80
⁴ Cooling - Efficiency I.E.E.R.	11.00	11.00	11.00	11.00	11.00	11.00	11.00	11.00
⁵ Heating Input BTUH (High)-Nat.	180,000	180,000	270,000	270,000	270,000	270,000	315,000	315,000
Heating Output BTUH (High)-Nat.	144,000	144,000	216,000	216,000	216,000	216,000	252,000	252,000
Heating Input BTUH (Low)-Nat.	117,000	117,000	175,000	175,000	175,000	175,000	205,000	205,000
Heating Output BTUH (Low)-Nat.	94,000	94,000	140,000	140,000	140,000	140,000	164,000	164,000
⁵ Heating Input BTUH (High)-L.P.	153,000	153,000	230,000	230,000	230,000	230,000	268,000	268,000
Heating Output BTUH (High)-L.P.	122,000	122,000	184,000	184,000	184,000	184,000	214,000	214,000
Heating Input BTUH (Low)-L.P.	100,000	100,000	149,000	149,000	149,000	149,000	174,000	174,000
Heating Output BTUH (Low)-L.P.	80,000	80,000	119,000	119,000	119,000	119,000	139,000	139,000
Heating-Steady State Efficiency	80.0%	80.0%	80.0%	80.0%	80.0%	80.0%	80.0%	80.0%
Electrical Rating - 60 Hz.								
Phase	3	3	3	3	3	3	3	3
Operating Voltage	187-253	414-506	187-253	414-506	187-253	414-506	187-253	414-506
Maximum Rated Ampacity-LSD ⁶ (Factory)	59.2	28.4	59.2	28.4	70.9	34.7	70.9	34.7
Maximum Rated Ampacity-HSD ⁷	64.4	30.7	64.4	30.7	70.9	34.7	70.9	34.7
Minimum Circuit Ampacity-LSD ⁶ (MCA)	64.8	31.1	64.8	31.1	77.2	37.8	77.2	37.8
Minimum Circuit Ampacity-HSD ⁷ (MCA)	70.0	33.4	70.0	33.4	77.2	37.8	77.2	37.8
Max. Overcurrent Protection-LSD ⁶ (MOP)	80	40	80	40	100	50	100	50
Max. Overcurrent Protection-HSD ⁷ (MOP)	90	40	90	40	100	50	100	50
Compressor Data								
Compressors (Scrolls)	2 ea.	2 ea.	2 ea.	2 ea.	2 ea.	2 ea.	2 ea.	2 ea.
Compressors (Scrolls)	ZP67KCE	ZP67KCE	ZP67KCE	ZP67KCE	ZP83KCE	ZP83KCE	ZP83KCE	ZP83KCE
Volts	208/230	460	208/230	460	208/230	460	208/230	460
Rated Load Amps	22.4	10.6	22.4	10.6	25.0	12.2	25.0	12.2
Lock Rotor Amps	149	75	149	75	164	100	164	100
Indoor Blower - Belt Drive								
Twin Blower Assembly								
Qty. - Wheel Diameter	2 - 12 x 12	2 - 12 x 12	2 - 12 x 12	2 - 12 x 12	2 - 12 x 12	2 - 12 x 12	2 - 12 x 12	2 - 12 x 12
Motor - HP/RPM	3 / 1725	3 / 1725	3 / 1725	3 / 1725	5 / 1725	5 / 1725	5 / 1725	5 / 1725
Motor Amps	8.8	4.4	8.8	4.4	14.0	6.7	14.0	6.7
Airflow Range	4000 - 5600				4800 - 6000			
Outdoor Fan(s)								
Motor-HP/RPM	2 ea.	2 ea.	2 ea.	2 ea.	3 ea.	3 ea.	3 ea.	3 ea.
Motor-HP/RPM	1/2-1075	1/2-1075	1/2-1075	1/2-1075	1/3-1075	1/3-1075	1/3-1075	1/3-1075
Motor Amps	2.8	1.4	2.8	1.4	2.3	1.2	2.3	1.2
Fan Diameter/CFM (High)	24"/10,000	24"/10,000	24"/10,000	24"/10,000	24"/12,600	24"/12,600	24"/12,600	24"/12,600
Refrigerant Charge - oz. R-410A								
Stage 1 Circuit	288	288	288	288	368	368	368	368
Stage 2 Circuit	310	310	310	310	368	368	368	368
High Pressure Switch (PSIG)	650 +/- 10 Manual Reset				650 +/- 10 Manual Reset			
Loss of Charge Switch (PSIG)	Cut Out: 5 +/- 5				Cut Out: 5 +/- 5			
	Cut In: 20 +/- 5				Cut In: 20 +/- 5			
Freeze Protection Thermostats	Opens (oF): 28 +/- 5				Opens (oF): 28 +/- 5			
	Closes (oF): 57 +/- 6				Closes (oF): 57 +/- 6			
Filters								
Style	Disposable - 2" Pleated				Disposable - 2" Pleated			
Size (Qty.)	16" x 20" x 2" (8)				16" x 20" x 2" (8)			
Gas Supply Size	3/4"				3/4"			

Footnotes:

Note - Net capacity includes indoor blower motor heat deduction. Gross capacity does not include indoor blower motor heat deduction.

¹Certified in accordance with AHRI Standard 340/360 at 95°F Outdoor DB and 80°Fdb/67°F wb evaporator entering air at minimum external duct static pressures allowed by the standard.

²E.E.R. - Energy Efficiency Ratio. E.E.R. is determined @ 95°F Outdoor DB & 80°F DB / 67°F WB Air Indoor

³I.P.L.V. - Integrated Part Load Value. Certified in accordance with AHRI Standard 340/360 @ 80°F DB / 67°F WB Outdoor & 80°F DB / 67°F WB Indoor

⁴I.E.E.R. - Integrated Energy Efficiency Ratio. Certified in accordance with AHRI Standard 340/360. Replaces I.P.L.V. rating as of 1/1/2010.

⁵Units listed with Gas Heating Capacities @ 225,000 Btu/hr and greater Input rates are rated in accordance with GAMA certification program

⁶LSD - Low Static Blower Drive (Standard)

⁷HSD - High Static Blower Drive Kit

R6GN-150(*) COOLING (With One Compressor Operating)

Single Stage Operation (One Compressor)

O.D.T			55°F			65°F			75°F			85°F		
CFM	E.D.B.	E.W.B.	T.C.	S.C.	kW	T.C.	S.C.	kW	T.C.	S.C.	kW	T.C.	S.C.	kW
4675	75	62	81.00	60.75	6.14	80.80	61.41	6.59	72.9	56.1	6.88	68.3	52.6	6.46
		67	86.20	46.55	6.26	86.00	48.10	6.71	78.1	43.7	7.00	73.5	39.5	7.58
		72	93.50	32.73	6.38	93.30	33.80	6.83	85.4	31.6	7.12	80.7	29.9	7.70
	80	62	79.30	70.58	6.14	79.10	72.10	6.59	71.2	64.8	6.86	64.2	59.1	7.31
		67	87.30	59.36	6.26	87.10	60.10	6.71	79.2	55.4	6.98	72.2	50.5	7.43
		72	94.60	45.41	6.35	94.40	46.26	6.82	86.5	43.3	7.07	79.5	40.5	7.34
5000	75	62	81.80	61.35	6.38	81.60	62.02	6.87	73.7	56.7	7.14	66.7	51.4	7.59
		67	87.00	46.98	6.50	86.80	47.74	6.99	78.9	44.2	7.26	71.9	40.3	7.71
		72	94.20	32.97	6.62	94.00	33.84	7.11	86.1	31.9	7.38	79.1	29.3	7.83
	80	62	82.90	73.60	6.44	82.70	74.43	6.92	74.8	68.8	7.16	67.8	63.7	7.61
		67	88.10	60.10	6.56	87.90	60.00	7.01	80.0	57.3	7.28	73.0	53.5	7.73
		72	93.90	45.07	6.65	93.70	46.30	7.10	85.8	43.8	7.37	78.8	41.8	7.82
5325	75	62	82.00	63.14	6.47	81.80	63.80	6.92	73.9	58.4	7.19	66.9	52.9	7.64
		67	87.20	48.83	6.59	87.00	49.59	7.04	79.1	45.9	7.31	72.1	41.8	7.76
		72	94.40	34.93	6.71	94.20	35.80	7.16	86.3	33.7	7.43	79.3	30.9	7.88
	80	62	83.10	76.45	6.49	82.90	77.10	6.94	75.0	71.3	7.21	68.0	66.0	7.66
		67	88.30	62.69	6.61	88.10	63.10	7.06	80.2	59.3	7.33	73.2	55.6	7.78
		72	94.10	47.99	6.70	93.90	48.83	7.15	86.0	46.4	7.42	79.0	44.2	7.87

R6GN-150(*) COOLING (With Two Compressors Operating)

2 Stage Operation (Two Compressors)

O.D.T			85°F			95°F			105°F			115°F		
CFM	E.D.B.	E.W.B.	T.C.	S.C.	kW	T.C.	S.C.	kW	T.C.	S.C.	kW	T.C.	S.C.	kW
4675	75	62	144.5	109.8	12.23	134.2	107.4	13.21	123.2	103.5	14.41	111.3	94.6	16.04
		67	156.0	88.6	12.51	145.7	84.5	13.49	134.7	82.2	14.69	122.8	76.1	16.32
		72	171.1	58.2	12.73	160.8	57.9	13.71	149.8	58.4	14.91	137.9	55.2	16.54
	80	62	145.8	137.2	12.29	135.5	128.7	13.27	124.5	122.0	14.47	112.6	111.5	16.10
		67	157.3	113.9	12.57	147.0	108.8	13.55	136.0	106.1	14.75	124.1	98.0	16.38
		72	172.4	86.2	12.79	162.1	87.5	13.77	151.1	84.6	14.97	139.2	79.3	16.60
5000	75	62	144.2	112.5	12.39	133.9	109.8	12.37	123.9	105.3	14.57	111.0	95.5	16.20
		67	155.7	90.3	12.67	145.4	87.2	13.65	134.4	84.7	14.85	122.5	77.0	16.48
		72	170.8	61.5	12.89	160.5	61.0	13.87	149.5	61.3	15.07	137.6	56.4	16.70
	80	62	146.8	140.9	12.44	136.5	133.8	13.42	125.5	124.2	14.62	113.6	113.6	16.25
		67	158.3	116.7	12.72	148.0	112.0	13.70	137.0	109.3	14.90	125.1	101.2	16.53
		72	173.4	90.2	12.94	163.1	88.1	13.92	152.1	88.2	15.12	140.2	82.7	16.75
5325	75	62	145.9	116.7	12.51	135.6	113.9	13.49	124.6	109.6	14.69	112.7	100.3	16.32
		67	157.4	94.4	12.79	147.1	91.2	13.77	136.1	88.5	14.97	124.2	82.0	16.60
		72	172.5	65.6	13.01	162.2	64.9	13.99	151.2	65.0	15.19	139.3	61.3	16.82
	80	62	148.5	145.5	12.56	138.2	136.8	13.54	127.2	125.9	14.74	115.3	115.3	16.37
		67	160.0	121.2	12.84	149.7	116.8	13.82	138.7	113.7	15.02	126.8	105.2	16.65
		72	175.1	94.6	13.06	164.8	92.3	14.04	153.8	92.3	15.24	141.9	86.6	16.87

Notes:

- 1) T.C. = Total (Net) Cooling Capacity, S.C. = Sensible Cooling Capacity, kW = Kilowatts
- 2) Expanded Ratings are based on 230 Volt - 60 Hz operation
- 3) Bolded Values indicate ARI rating points
- 4) Energy Efficiency Ratio (EER) = T.C. / kW

R6GN-0180(*) COOLING (With One Compressor Operating)

Single Stage Operation (One Compressor)

O.D.T			55°F			65°F			75°F			85°F		
CFM	E.D.B.	E.W.B.	T.C.	S.C.	kW	T.C.	S.C.	kW	T.C.	S.C.	kW	T.C.	S.C.	kW
5025	75	62	89.8	68.2	7.41	92.7	69.5	8.00	89.9	69.2	8.59	84.2	64.8	9.17
		67	92.3	49.2	7.57	95.2	50.2	8.16	92.4	4897.2	8.75	86.7	45.7	9.33
		72	94.9	35.7	7.71	97.8	35.7	8.30	95.0	35.4	8.89	89.3	33.0	9.47
	80	62	87.5	77.9	7.69	90.4	79.6	8.09	87.6	78.0	8.84	81.7	73.5	9.40
		67	94.4	62.8	7.85	97.3	63.8	8.25	94.5	63.7	9.00	88.6	60.2	9.56
		72	95.5	47.8	8.03	98.4	48.2	8.43	95.6	48.8	9.18	89.7	45.7	9.74
5400	75	62	89.5	68.5	7.64	91.9	69.8	8.02	89.6	69.9	8.77	83.4	65.1	9.33
		67	91.5	50.3	7.78	94.4	50.9	8.18	91.6	51.1	8.93	85.9	48.5	9.49
		72	94.1	36.9	7.92	97.0	37.1	8.32	94.2	37.8	9.07	88.5	36.1	9.63
	80	62	86.7	78.0	7.71	89.6	79.7	8.11	86.8	79.0	8.86	80.9	73.6	9.42
		67	93.6	63.4	7.87	96.5	64.4	8.27	93.7	64.3	9.02	87.8	60.8	9.58
		72	94.7	48.3	8.05	97.6	48.4	8.45	94.8	49.3	9.20	88.9	46.2	9.76
5775	75	62	87.9	69.4	7.90	90.8	70.8	8.30	88.0	70.4	9.05	82.3	65.8	9.61
		67	90.4	51.2	8.06	93.3	51.8	8.46	90.5	52.0	9.21	84.8	49.4	9.77
		72	93.0	38.0	8.20	95.9	38.2	8.60	93.1	38.9	9.35	87.4	37.2	9.91
	80	62	85.6	77.9	7.99	88.5	79.7	8.39	85.7	78.8	9.14	79.8	73.4	9.70
		67	92.5	64.2	8.15	95.4	65.2	8.55	92.6	65.1	9.30	86.7	61.6	9.86
		72	93.6	48.7	8.33	96.5	49.2	8.73	93.7	49.7	9.48	87.8	46.5	10.04

R6GN-0180(*) COOLING (With Two Compressor Operating)

2 Stage Operation (Two Compressors)

O.D.T			85°F			95°F			105°F			115°F		
CFM	E.D.B.	E.W.B.	T.C.	S.C.	kW	T.C.	S.C.	kW	T.C.	S.C.	kW	T.C.	S.C.	kW
5025	75	62	171.0	133.4	15.00	161.2	127.4	14.80	149.2	119.4	17.57	135.1	109.4	19.69
		67	187.9	102.4	15.38	177.2	98.3	15.14	164.0	92.6	17.95	148.5	85.4	20.07
		72	206.5	80.5	15.77	194.7	77.9	15.50	180.2	73.9	18.34	163.1	68.5	20.46
	80	62	173.1	157.3	15.05	163.3	150.2	14.85	151.1	142.0	17.62	136.9	134.1	19.74
		67	188.2	130.2	15.43	177.5	127.8	15.19	164.3	120.7	18.00	148.8	112.3	20.12
		72	204.6	106.4	15.83	192.9	102.2	15.55	178.5	98.2	18.39	161.7	93.8	20.51
5400	75	62	172.9	138.3	15.24	163.5	132.5	16.24	150.7	123.6	18.25	137.1	115.2	20.21
		67	190.0	103.6	15.63	179.7	99.7	16.62	165.6	93.6	18.64	150.7	86.7	20.60
		72	208.8	83.5	16.01	197.5	81.0	17.01	182.0	76.4	19.04	165.6	72.9	21.00
	80	62	175.1	162.8	15.29	165.6	155.7	16.29	152.6	146.5	18.30	138.9	137.5	20.26
		67	190.3	135.5	15.68	180.0	129.5	16.67	165.9	122.0	18.69	151.0	116.0	20.65
		72	206.8	111.7	16.08	195.7	107.6	17.06	180.3	102.8	19.09	164.1	98.5	21.05
5775	75	62	173.7	142.4	15.41	163.9	136.1	16.34	151.9	129.1	17.98	137.8	121.3	20.10
		67	190.9	104.0	15.80	180.2	100.0	16.73	167.0	94.3	18.37	151.5	87.1	20.49
		72	209.8	86.0	16.21	198.0	83.1	17.12	183.5	80.7	18.76	166.4	78.2	20.89
	80	62	175.9	167.1	15.45	166.0	159.4	16.39	153.9	150.8	18.03	139.6	139.6	20.15
		67	191.2	139.5	15.85	180.5	129.9	16.78	167.3	122.9	18.42	151.8	114.6	20.54
		72	207.8	116.4	16.26	196.1	111.8	17.17	181.8	107.3	18.82	164.9	102.3	20.94

Notes

- 1) T.C. = Total (Net) Cooling Capacity, S.C. = Sensible Cooling Capacity, kW = Kilowatts
- 2) Expanded Ratings are based on 230 Volt - 60 Hz operation
- 3) Bolded Values indicate ARI rating point
- 4) Energy Efficiency Ratio (EER) = T.C. / kW

BLOWER PERFORMANCE R6GN-150 SERIES

3 HP LOW STATIC DRIVE KIT

Motor Sheave Position	External Static Pressures (Inches Water Column)																					
	0.3		0.4		0.5		0.6		0.7		0.8		0.9		1.00		1.10					
	CFM	Kw	CFM	RPM	Kw	CFM	RPM	Kw	CFM	RPM	Kw	CFM	RPM	Kw	CFM	RPM	Kw	CFM	RPM	Kw		
Fully Closed																						
1/2 Turns Open																						
1 Turns Open																						
1.5 Turns Open																						
2 Turns Open																						
2.5 Turns Open																						
3.0 Turns Open																						
3.5 Turns Open																						
4.0 Turns Open*																						
4.5 Turns Open																						
5.0 Turns Open																						

5 HP HIGH STATIC DRIVE KIT

Motor Sheave Position	External Static Pressures (Inches Water Column)																					
	1.1		1.2		1.3		1.40		1.50		1.60		1.7		1.80		1.90					
	CFM	Kw	CFM	RPM	Kw	CFM	RPM	Kw	CFM	RPM	Kw	CFM	RPM	Kw	CFM	RPM	Kw	CFM	RPM	Kw		
Fully Closed																						
1/2 Turn Open																						
1 Turn Open																						
1.5 Turns Open																						
2.0 Turns Open																						
2.5 Turns Open																						
3.0 Turns Open																						
3.5 Turns Open																						
4.0 Turns Open*																						
4.5 Turns Open																						
5.0 Turns Open																						

NOTES:

- * Denotes Factory sheave setting.
- Low Static Drive Consists of: 3 Hp Motor; 1VP60 Motor Sheave; BK95H Blower Pulley & BX52 belt.
- High Static Drive Consists of: 5 Hp Motor; 1VP68 Motor Sheave; BK85H Blower Pulley & BX50 belt.
- Values include losses for air filters, unit casing, and dry evaporator coil.
- See Accessory Performance Data table for additional static pressure information.

BLOWER PERFORMANCE R6GN-180 SERIES

5 HP LOW STATIC DRIVE KIT																		
External Static Pressures (Inches Water Column)																		
Motor Sheave Position	0.3		0.4		0.5		0.6		0.7		0.8		0.9		1.00		1.10	
	CFM	RPM	Kw	CFM	RPM	Kw	CFM	RPM	Kw	CFM	RPM	Kw	CFM	RPM	Kw	CFM	RPM	Kw
Fully Closed																		
1/2 Turn Open																		
1 Turn Open																		
1.5 Turns Open																		
2.0 Turns Open																		
2.5 Turns Open																		
3.0 Turns Open																		
3.5 Turns Open																		
4.0 Turns Open*																		
4.5 Turns Open																		
5.0 Turns Open																		

5 HP HIGH STATIC DRIVE KIT																		
External Static Pressures (Inches Water Column)																		
Motor Sheave Position	1.1		1.2		1.3		1.40		1.50		1.60		1.7		1.80		1.90	
	CFM	RPM	Kw	CFM	RPM	Kw	CFM	RPM	Kw	CFM	RPM	Kw	CFM	RPM	Kw	CFM	RPM	Kw
Fully Closed																		
1/2 Turn Open																		
1 Turn Open																		
1.5 Turns Open																		
2.0 Turns Open																		
2.5 Turns Open																		
3.0 Turns Open																		
3.5 Turns Open																		
4.0 Turns Open*																		
4.5 Turns Open																		
5.0 Turns Open																		

NOTES:	
	* Denotes Factory sheave setting.
	Low Static Drive Consists of: 5 Hp Motor; 1VP65 Motor Sheave; BK95H Blower Pulley & BX52 belt.
	High Static Drive Consists of: 5 Hp Motor; 1VP68 Motor Sheave; BK85H Blower Pulley & BX50 belt.
	Values include losses for air filters, unit casing, and dry evaporator coil.
	See Accessory Performance Data table for additional static pressure information.

R6GN-150/180(*) Accessory Performance Data

Model No.	Air Volume (CFM)	Total Resistance (inches water column)						
		Wet Evaporator Coil	Downflow Economizer	Horizontal Economizer	Step Down Diffuser System	* Throw Feet	Flush Mount Diffuser System	* Throw Feet
R6GN-150	4000	0.11	0.08	0.05	0.28	23-28	0.27	21-29
	4200	0.12	0.08	0.05	0.29	24-29	0.28	22-30
	4400	0.13	0.09	0.05	0.30	25-30	0.30	23-31
	4600	0.14	0.09	0.06	0.31	26-31	0.31	25-33
	4800	0.15	0.10	0.06	0.32	27-32	0.32	26-34
	5000	0.16	0.10	0.06	0.34	28-33	0.34	27-35
	5200	0.17	0.11	0.07	0.36	28-34	0.36	29-38

Model No.	Air Volume (CFM)	Total Resistance (inches water column)						
		Wet Evaporator Coil	Down Flow Economizer	Horizontal Economizer	Step Down Diffuser System	* Throw Feet	Flush Mount Diffuser System	* Throw Feet
R6GN-180	4800	0.15	0.10	0.06	0.27	29-37	0.27	16-24
	5000	0.16	0.10	0.06	0.29	32-40	0.29	19-27
	5200	0.17	0.11	0.07	0.32	33-42	0.31	22-30
	5400	0.18	0.11	0.07	0.35	36-45	0.33	26-34
	5600	0.19	0.13	0.07	0.36	39-49	0.36	30-39
	5800	0.21	0.13	0.08	0.39	42-51	0.39	35-44
	6000	0.23	0.15	0.08	0.42	44-54	0.42	40-50

Bold italicized numbers indicate factory blower setting.

* The distance the air from the grille travels from the diffuser before it slows down to 50 ft. per minute. All sides open.

ACCESSORIES - 12-1/2 and 15 Ton R6GN

NORDYNE Part#	Description	R6GN -150	R6GN -180
559538	Hinged Roof Curb 8" High - K/D	X	X
559539	Hinged Roof Curb 14" High - K/D	X	X
559540	Hinged Roof Curb 18" High - K/D (Special Order)	X	X
559541	Hinged Roof Curb 24" High - K/D (Special Order)	X	X
560258	Adjustable Support Leg Kit	X	X
555621	Economizer - Modulating w/ Relief, Adapts Horizontal, Enthalpy Controlled	X	X
920233	Enthalpy Sensor Kit (Differential Enthalpy Control)	X	X
920317	CO2 Sensor - Wall Mount	X	X
920318	CO2 Sensor - Duct Mount	X	X
555622	Power Exhaust - Prop (208-230v/3ph), Adapts Horizontal (Special Order)	X	X
555623	Power Exhaust - Prop (460v/3ph), Adapts Horizontal (Special Order)	X	X
559542	Horizontal Roof Curb - 24" High (Special Order) (Requires 919251)	X	X
559543	Horizontal Roof Curb w/ Supply Duct- 24" High (Special Order) (Requires 919251)	X	X
919251	Horizontal Return Air Panel Kit (Requires 559542 or 559543)	X	X
555633	0-35% Motorized Damper - Only (Special Order) (Requires Kit 919275)	X	X
919275	Manual Fresh Air Kit (Panel & Hood)	X	X
555635	18" x 32" Supply & Return Transition (Special Order)	X	
555636	18" x 36" Supply & Return Transition (Special Order)		X
555637	18" x 32" Flush Mount Concentric Diffuser (Special Order)	X	
555638	18" x 36" Flush Mount Concentric Diffuser (Special Order)		X
555639	18" x 32" Step Down Concentric Diffuser (Special Order)	X	
555640	18" x 36" Step Down Concentric Diffuser (Special Order)		X
555641	Hooded Hail Guard (Special Order)	X	X
558863	Duct Smoke Detect. Photo Elect.	X	X
547893	Multi-signal control SSK 451	X	X
558864	Sampling Tube DST3, 2-4 ft.	X	X
558865	Sampling Tube DST5, 4-8 ft.	X	X
920619	Thermostat-2 stage Heat/Cool	X	X
920463	Low Ambient Kit, Light Commercial, R410A	X	X
918798	LP Gas / High Elevation Conversion Kit	X	X
918839	High Elevation Kit 12.5/15T (Nat. Gas) 2,000-4,000 Ft.	X	X
918840	High Elevation Kit 12.5/15T (Nat. Gas) 4,000-6,000 Ft.	X	X
918841	High Elevation Kit 12.5/15T (Nat. Gas) 6,000-7,000 Ft.	X	X
918799	High Static Blower Drive Kit-12.5 Ton	X	
918800	High Static Blower Drive Kit-15 Ton		X
919128	Current Sensing Compressor Lockout Kit	X	X



GENERAL TERMS OF LIMITED WARRANTY

NORDYNE will furnish a replacement for any part of this product which fails in normal use and service within the first year of installation, in accordance with the terms of the warranty.

For complete details of the Limited Warranty, including applicable terms and conditions, see your local installer or contact the NORDYNE warranty department for a copy.

NORDYNE

COMPLETE COMFORT. GENUINE VALUE.

8000 Phoenix Parkway | O'Fallon, MO 63368-3827

Specifications and illustrations subject to change without notice and without incurring obligations. Printed in U.S.A (01/2010)

370D-0313(Replaces 370D-0110)